

**LEGO**



8677



1

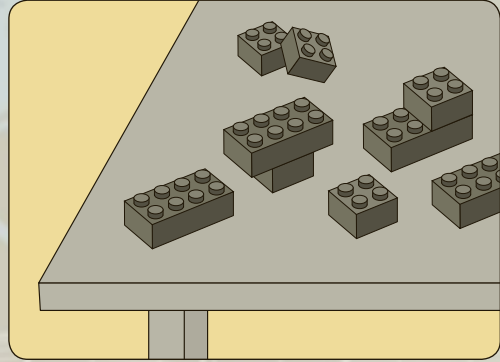
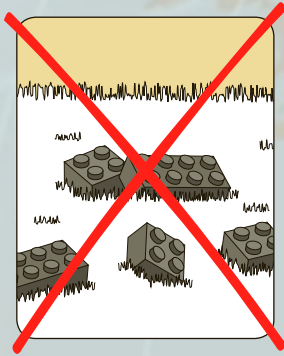

2



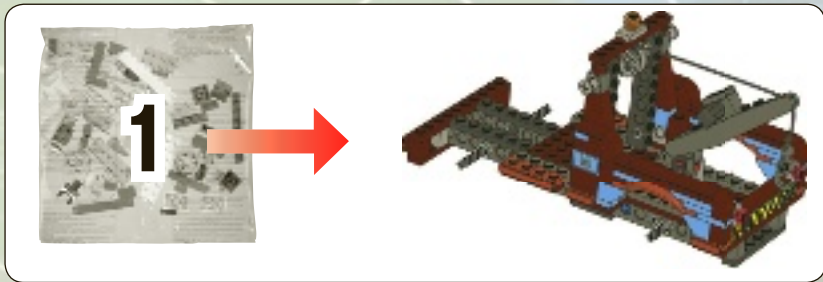

1





2

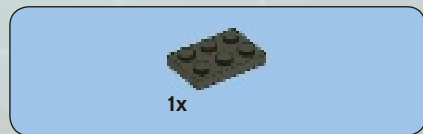

3

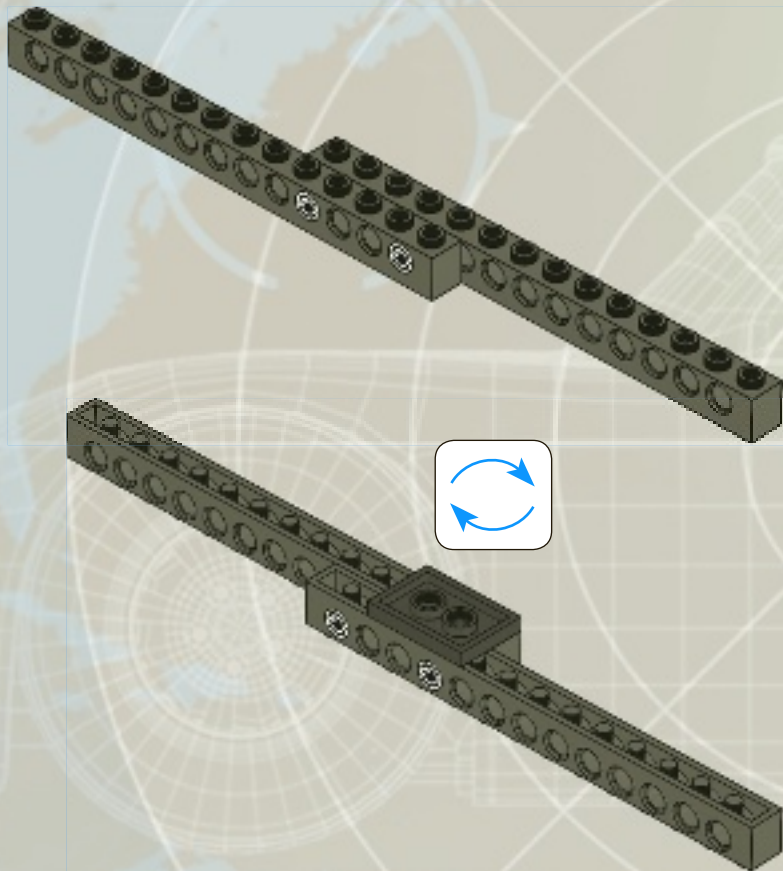

4

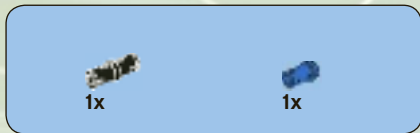

4

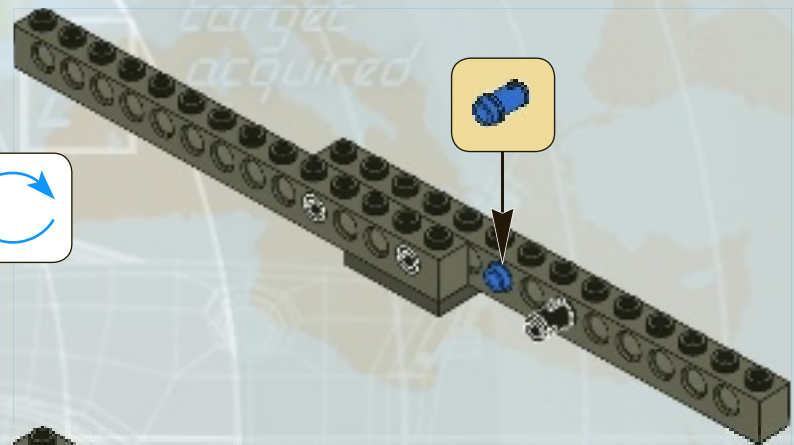

5

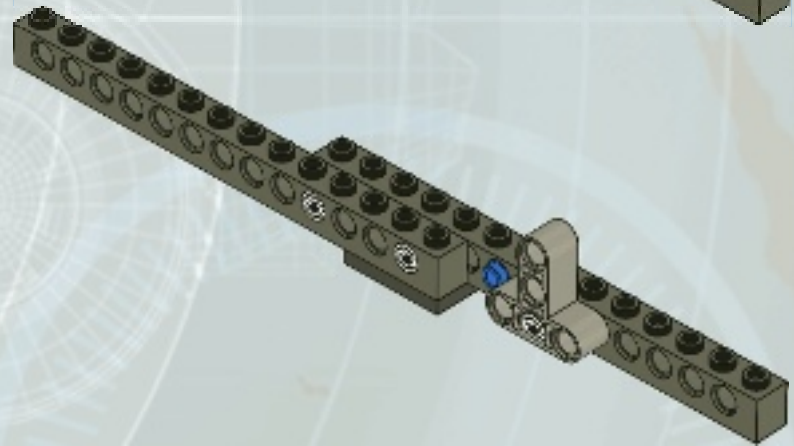

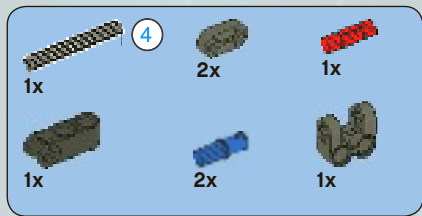

6

1



2



3



4



5

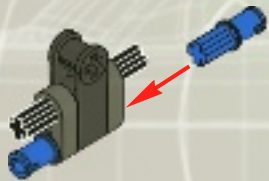

6

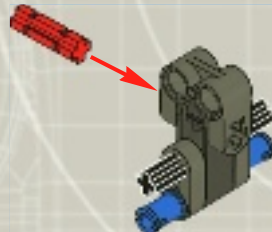

waypoint

2

target  
acquired

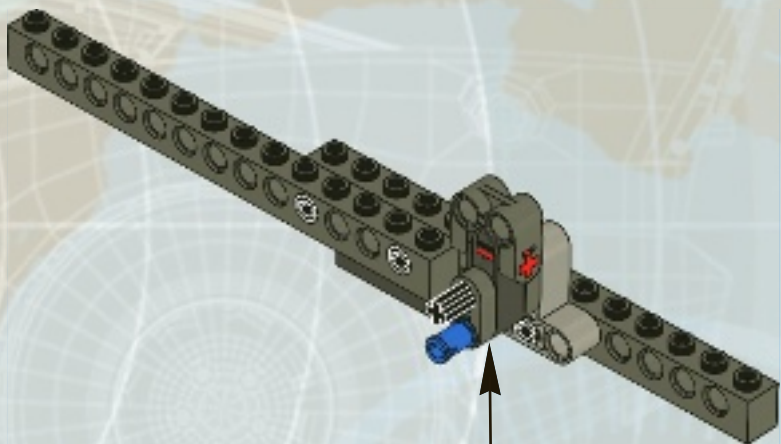

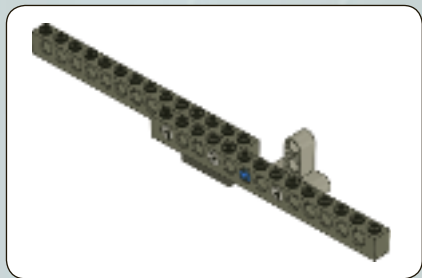

1

8





2

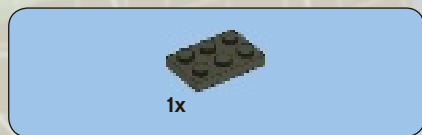

3

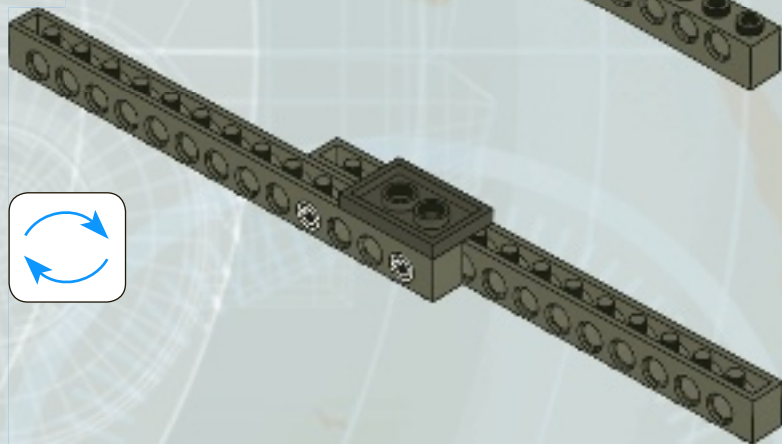
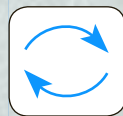

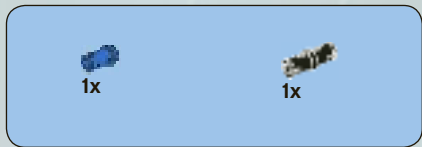

4

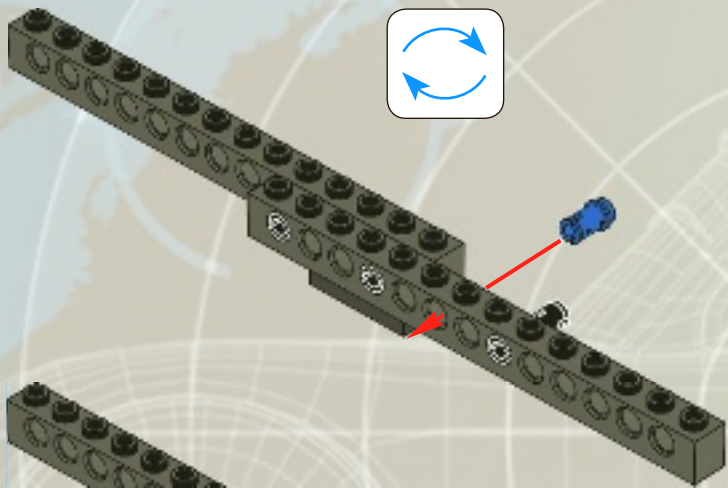

5

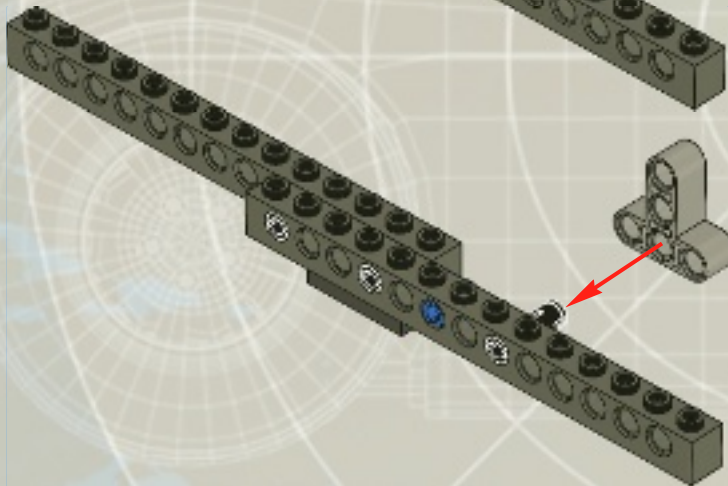

waypoint 2 target acquired

7

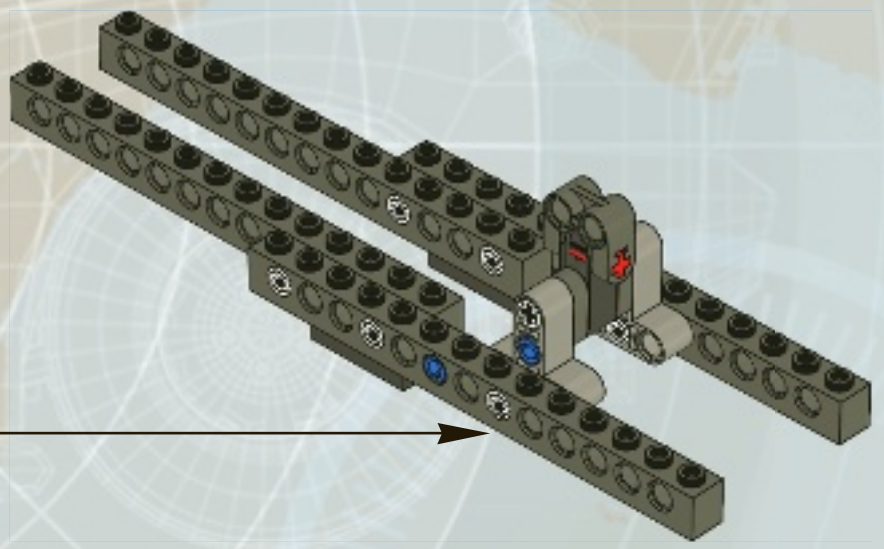

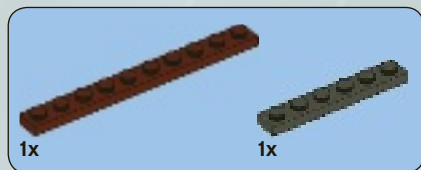

8

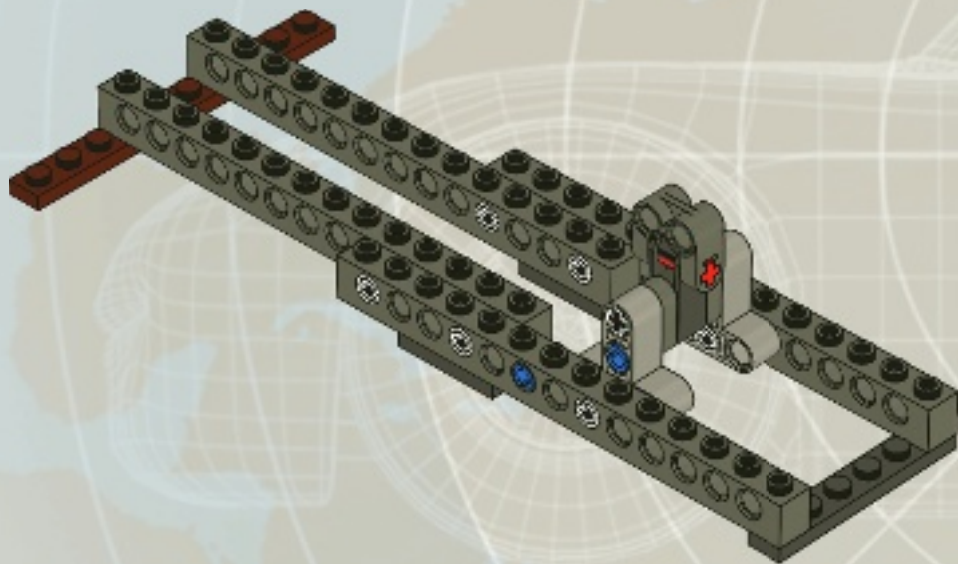

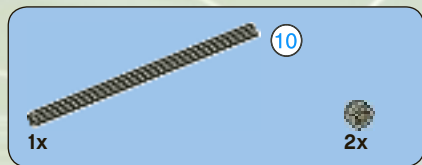

9

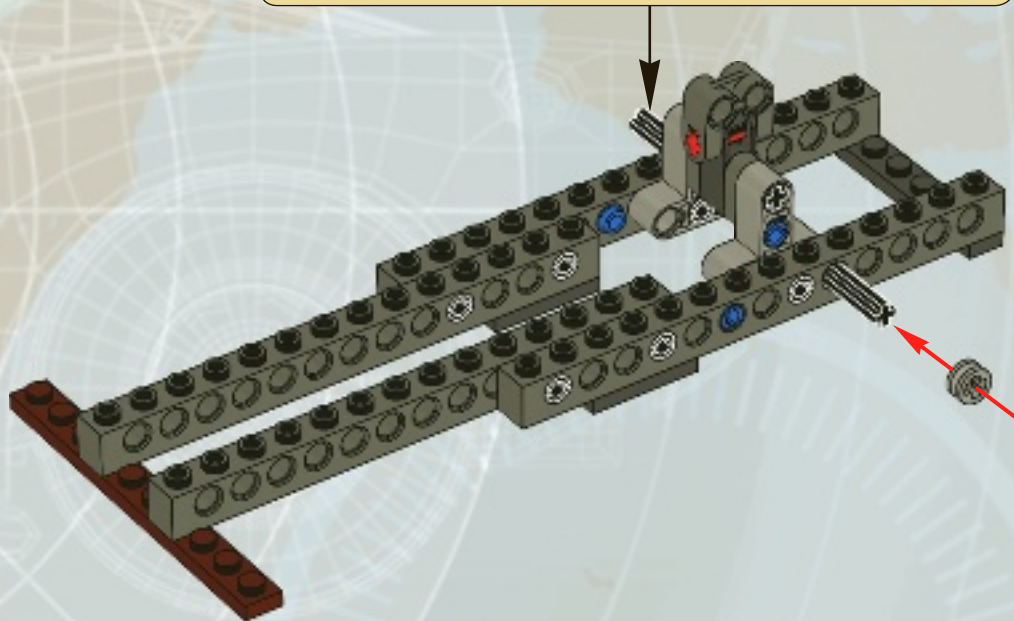

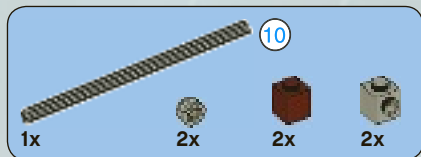

10

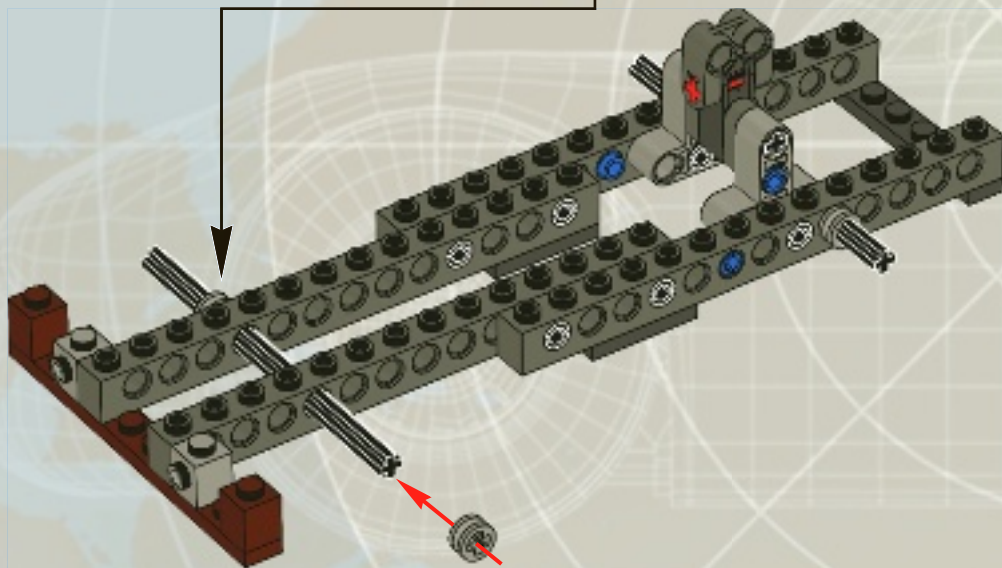

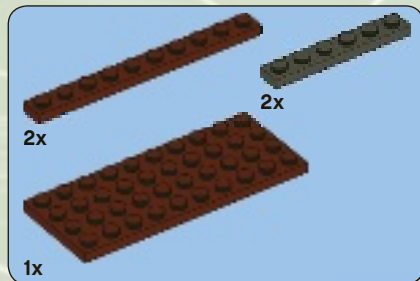

11

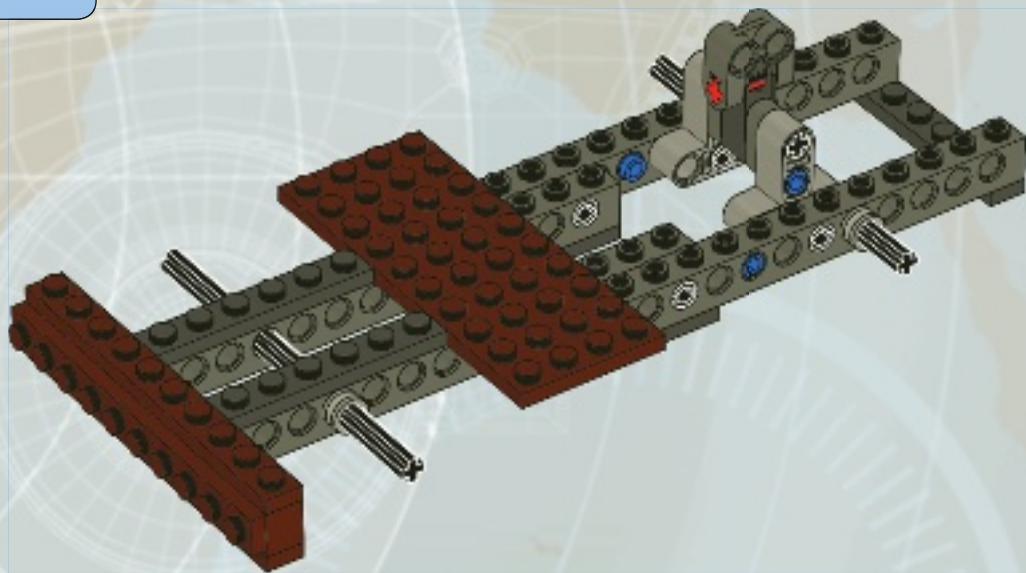

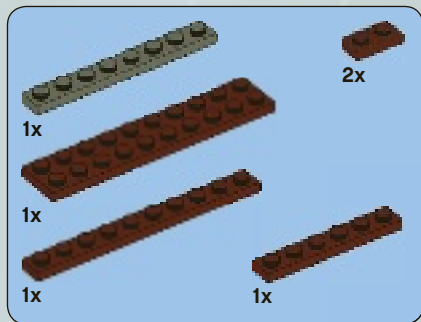

12

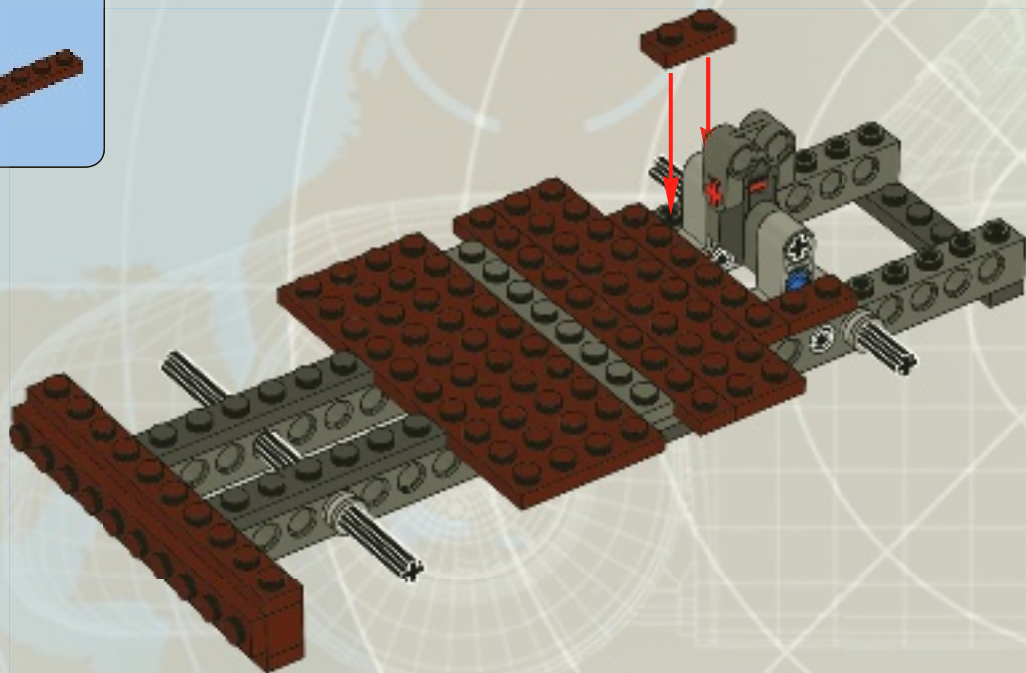



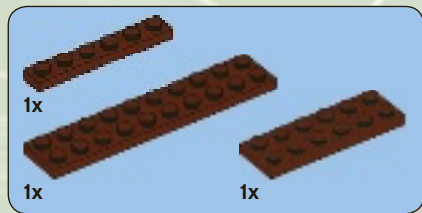

13

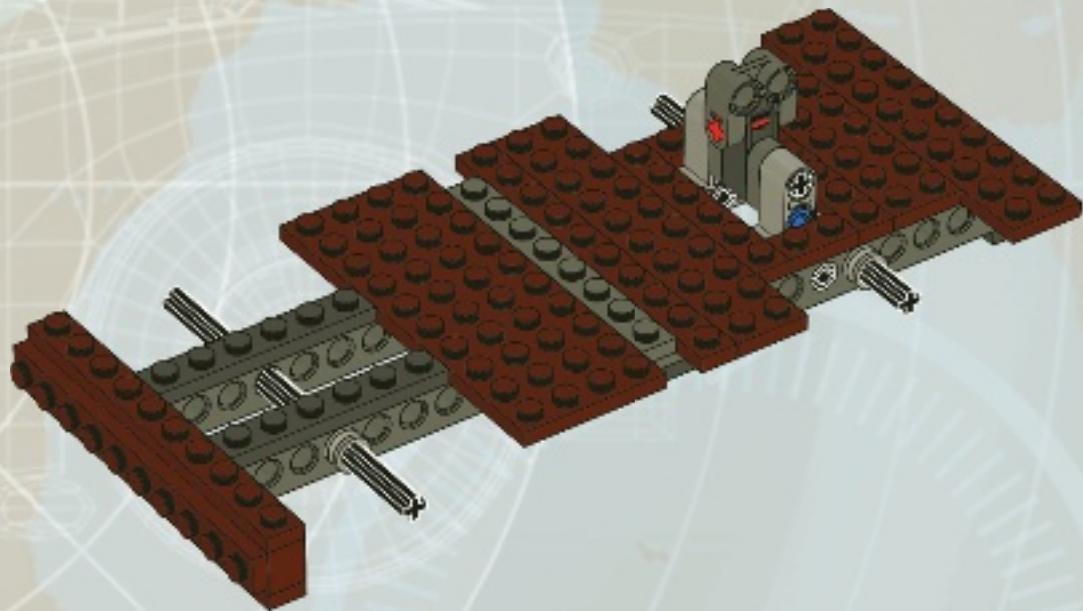

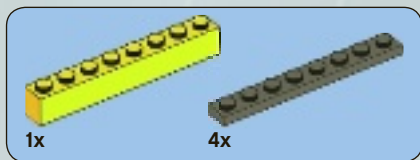

14

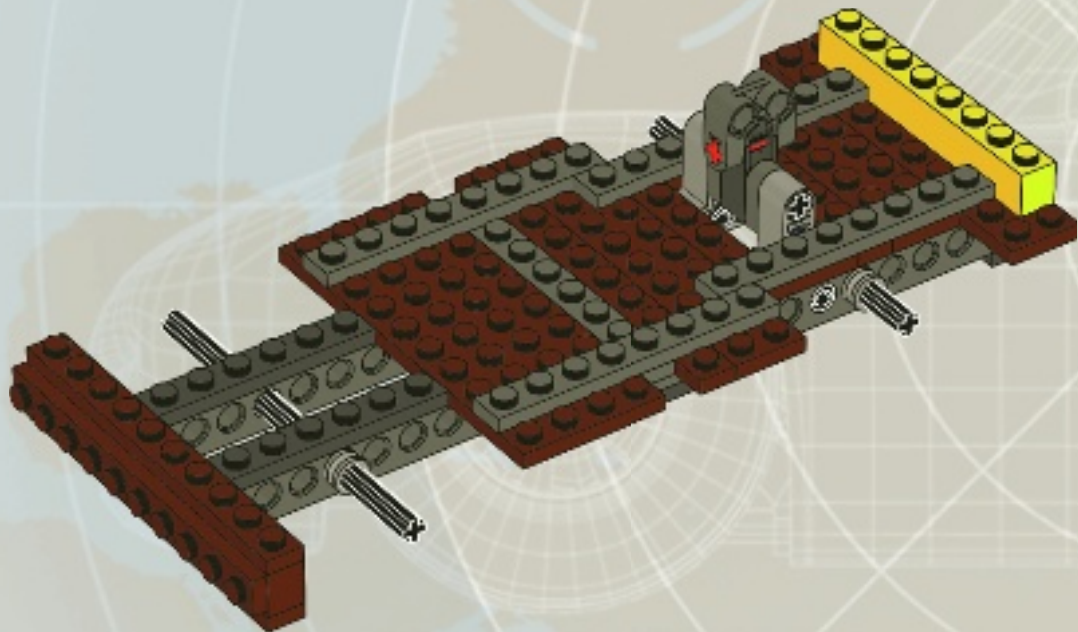



2x



8x

15

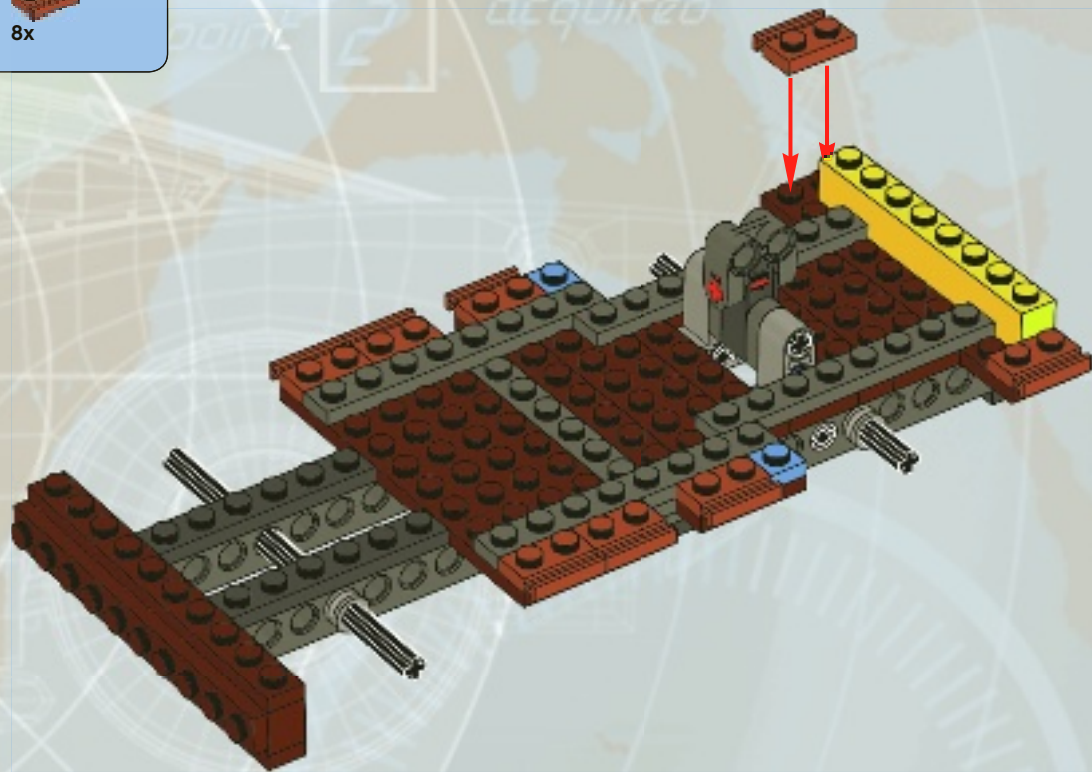

4x  4x 

16

2x 

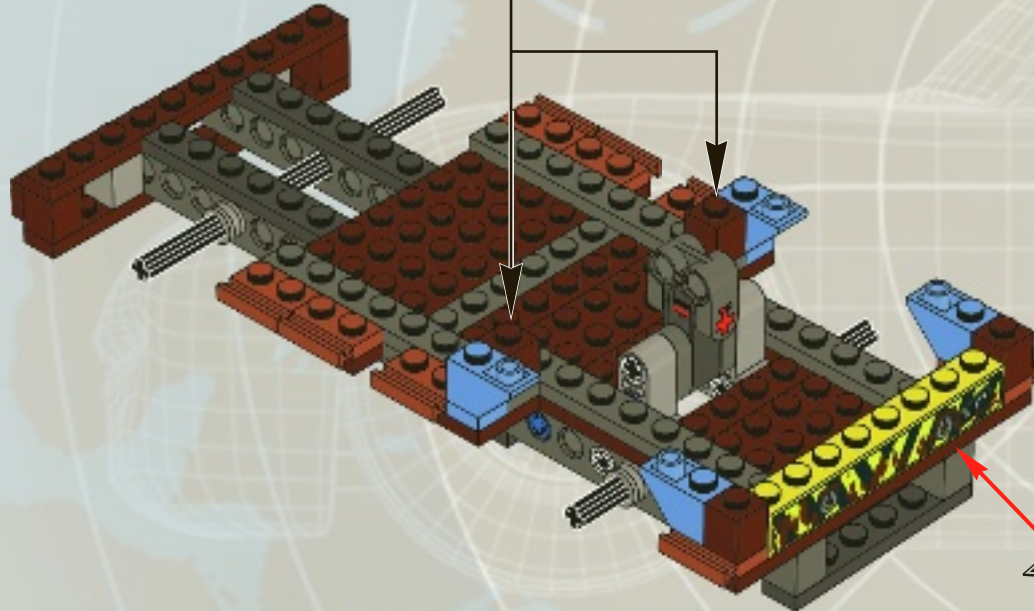







2x

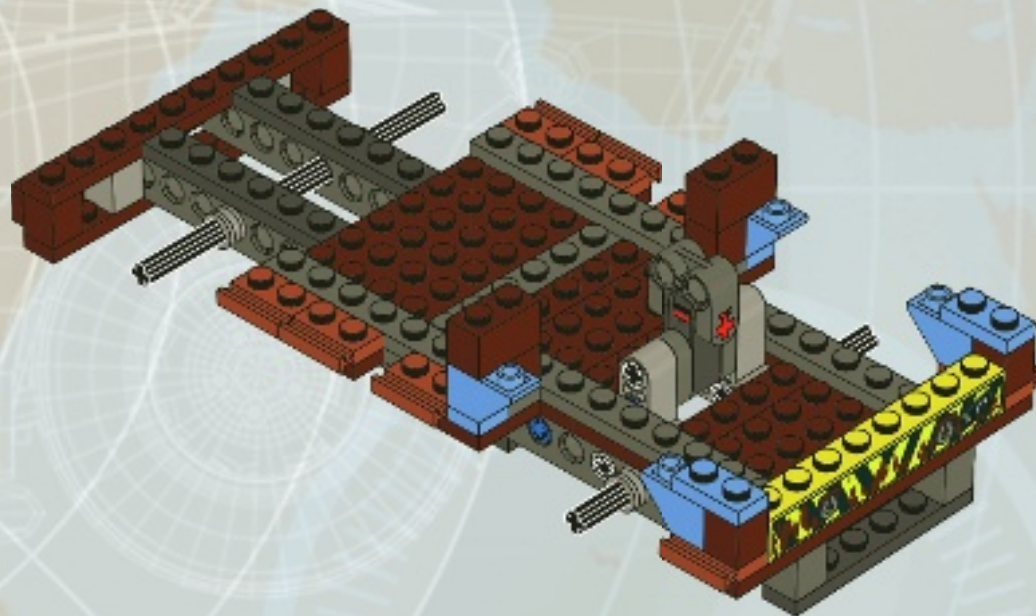

2x

17



2x  1x  2x 

# 18

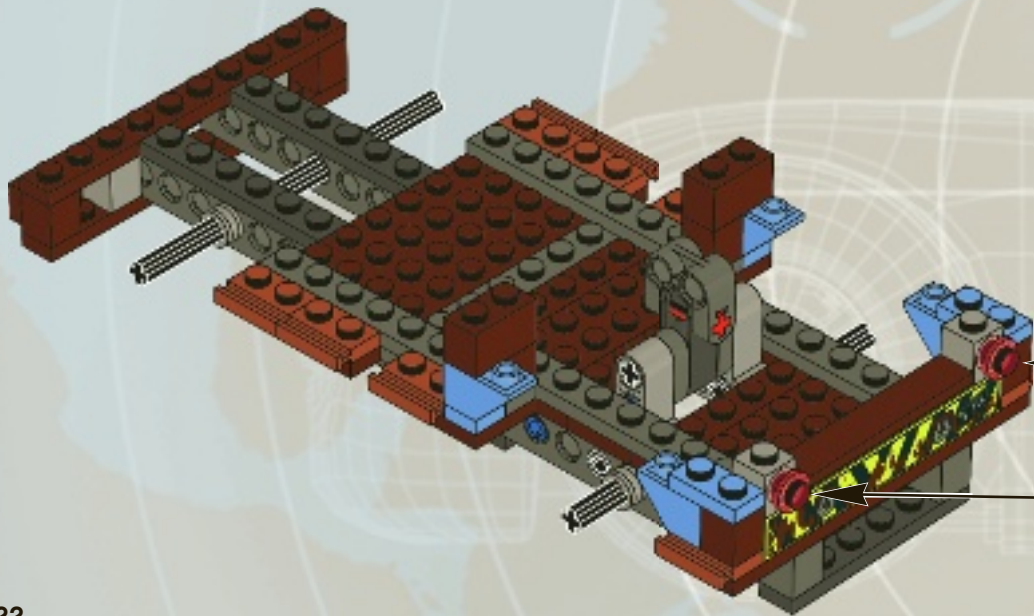

1 

2  2x



2x

19

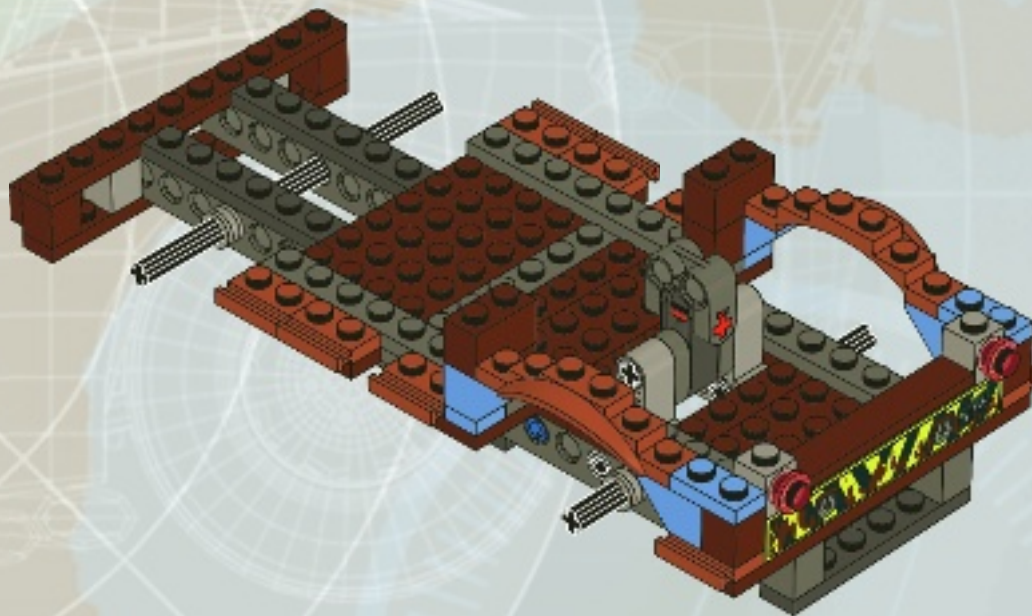



2x



2x

20

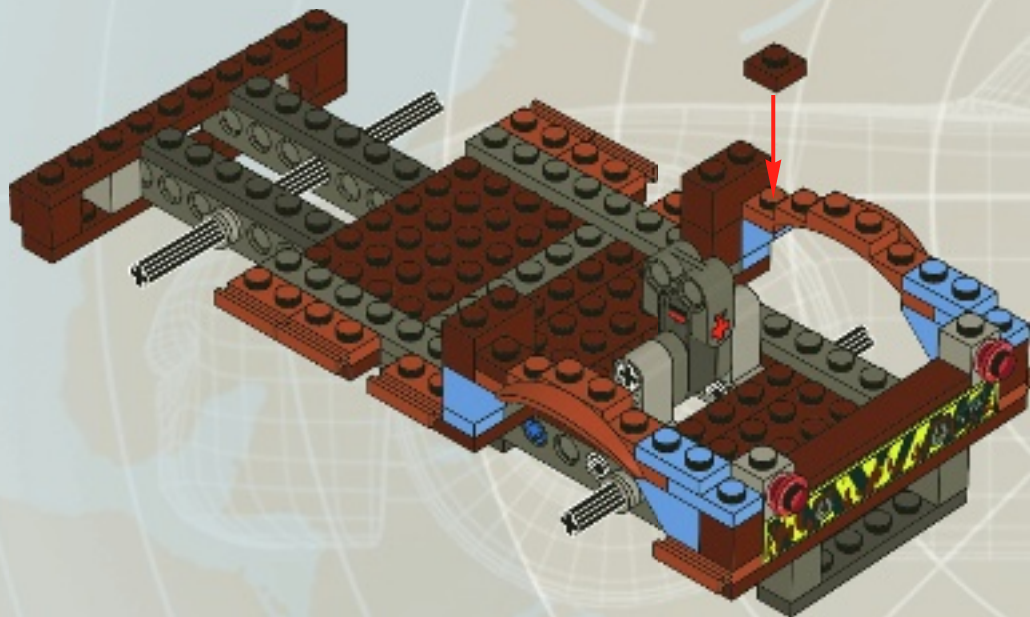





4x



2x

# 21

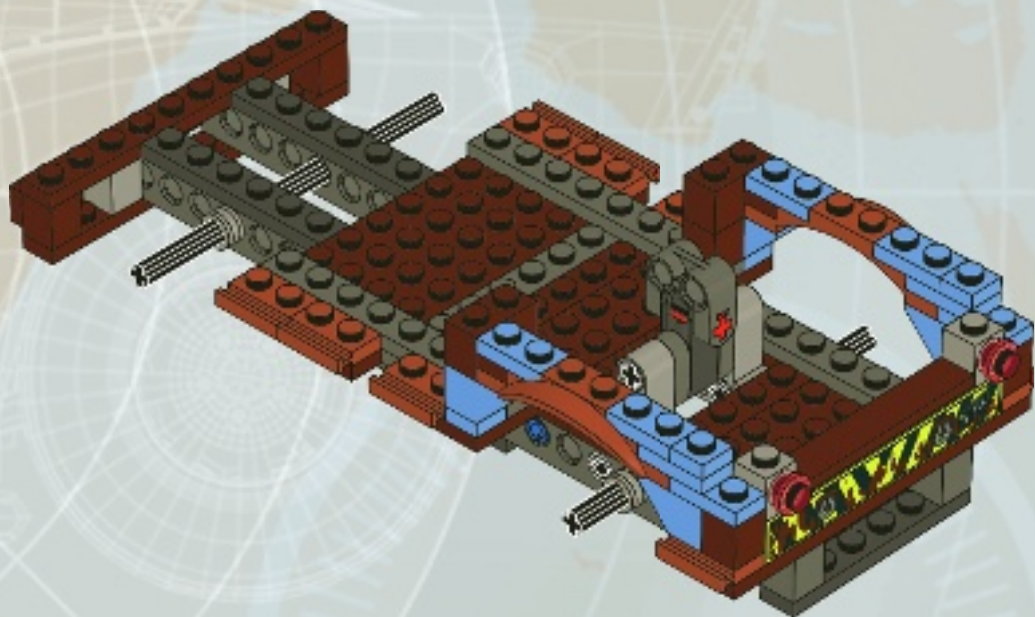



2x



2x



2x

22

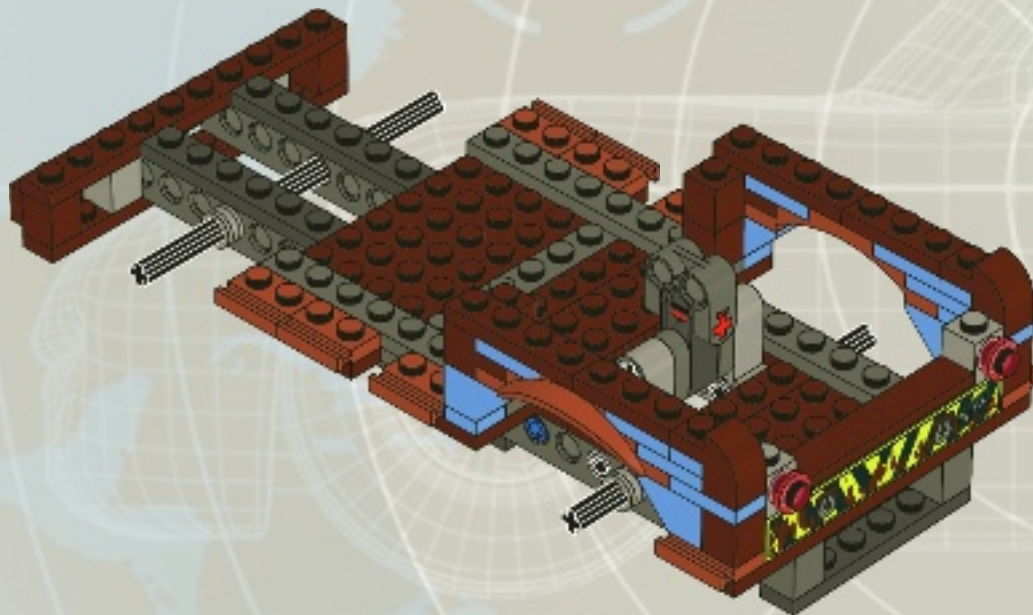



23

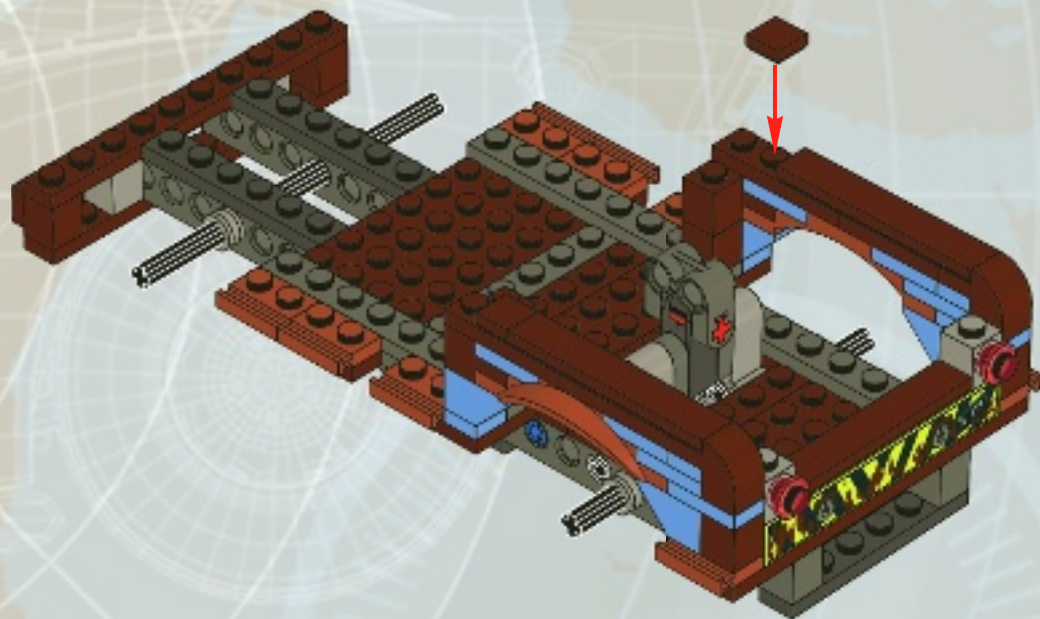

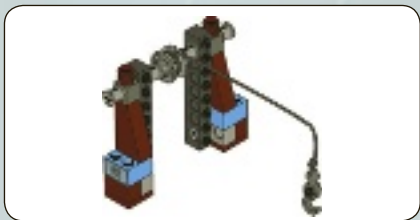

1



2

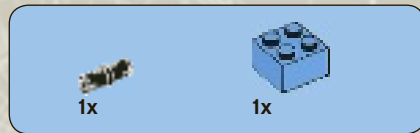
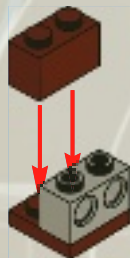

3





4



5



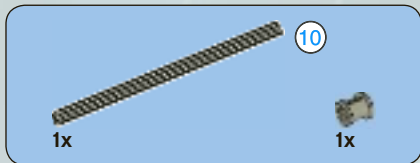

6

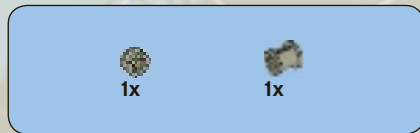
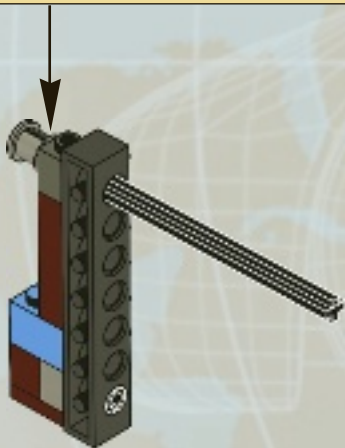
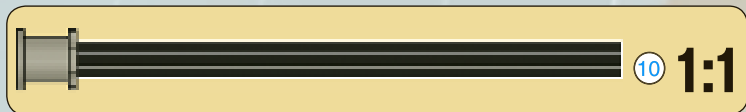

7

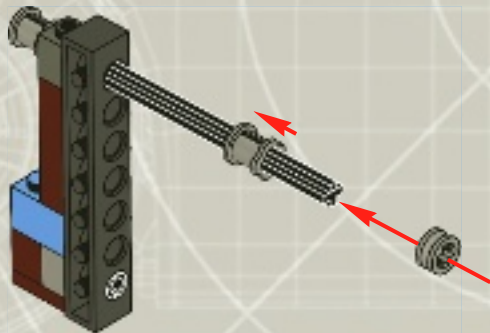

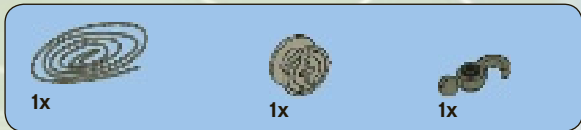

8

1



2



waypoint

7

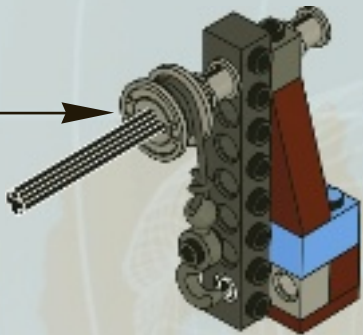

1x



1x

9

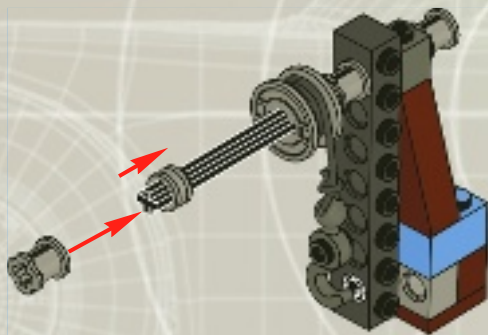



target  
acquired

point 2

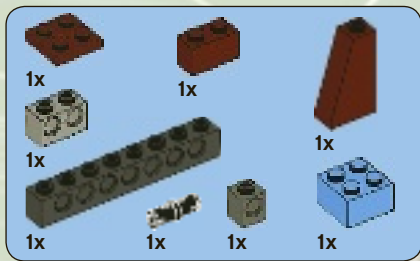

# 10

1



2

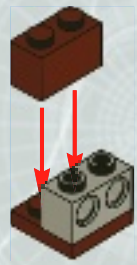

3



4



5

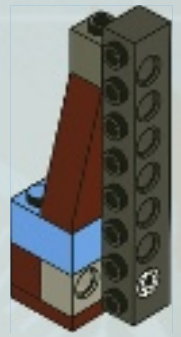

waypoint

7

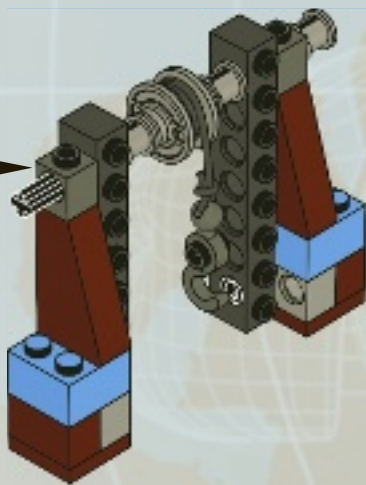

1x

11

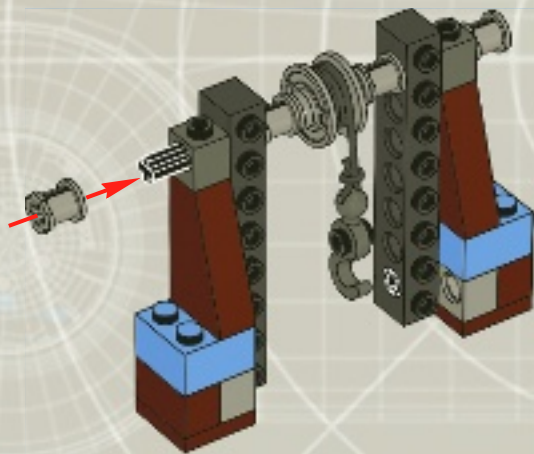



4x

12

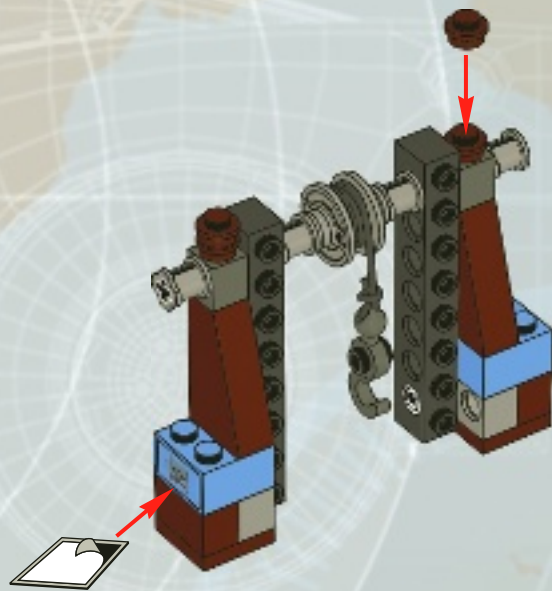

target  
acquired

point

2

24

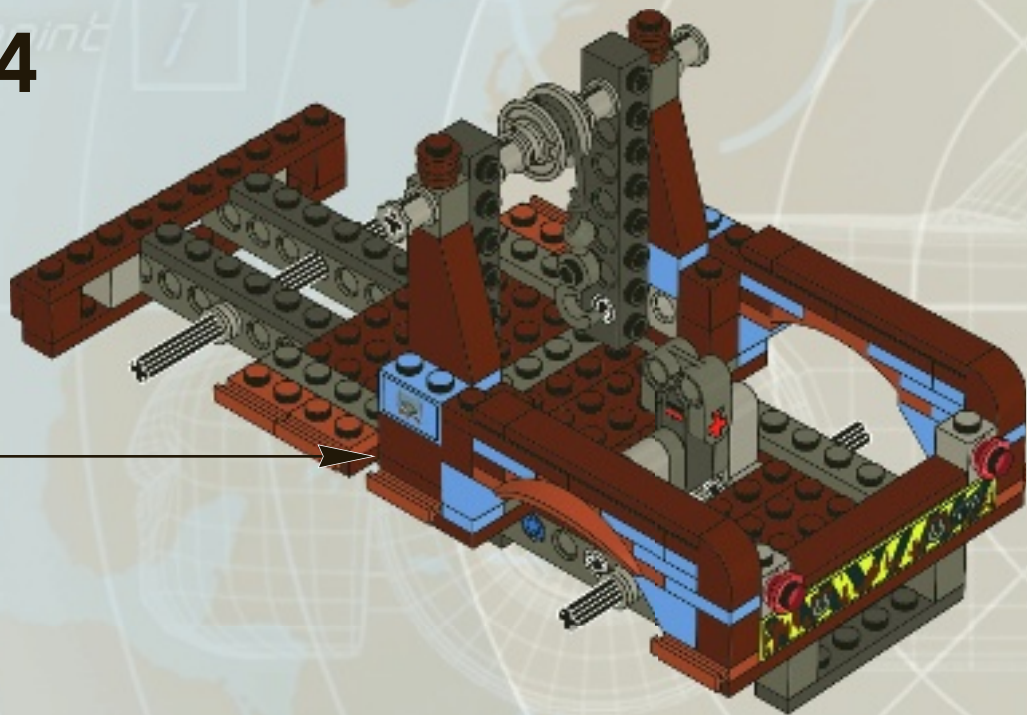



25

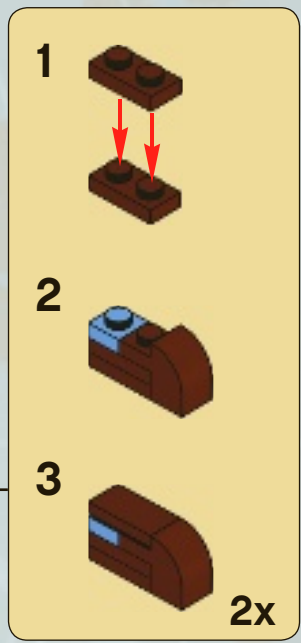
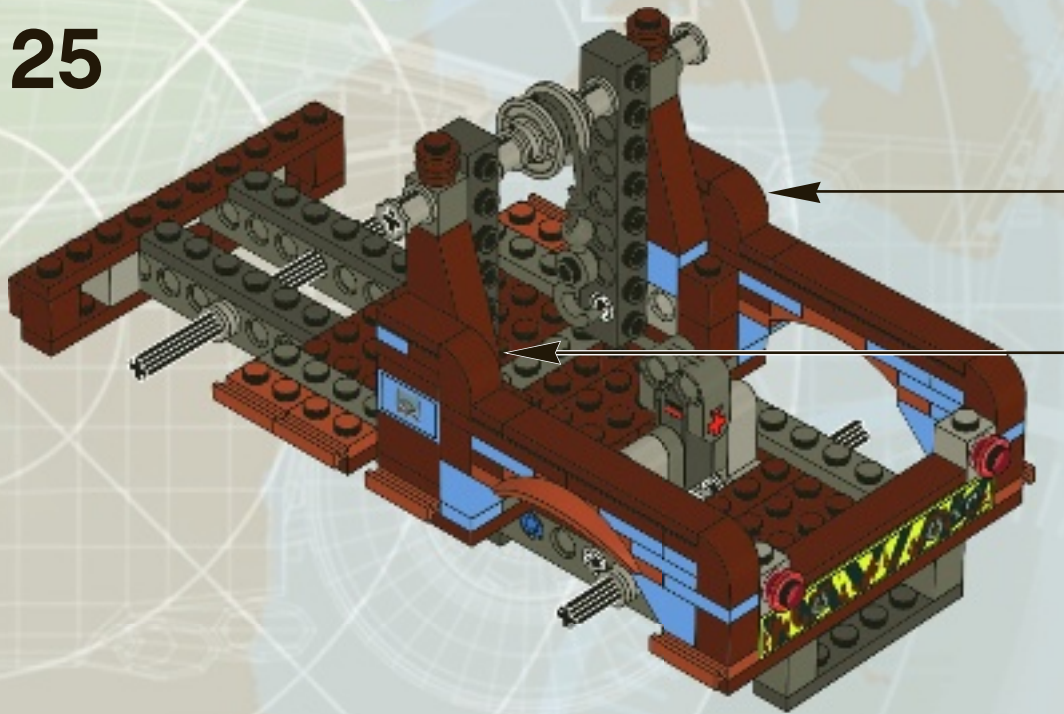

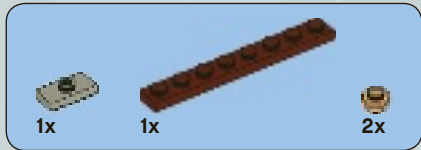

26

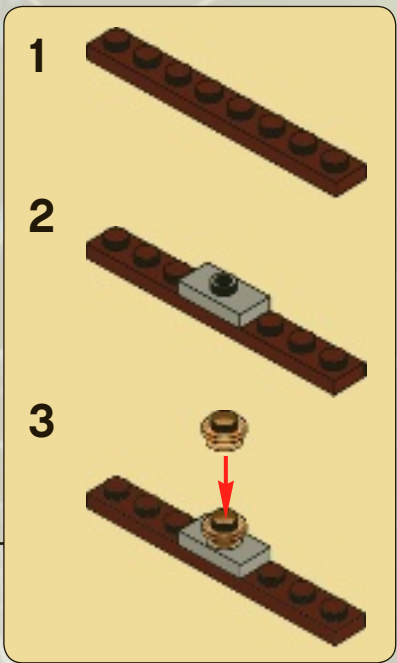
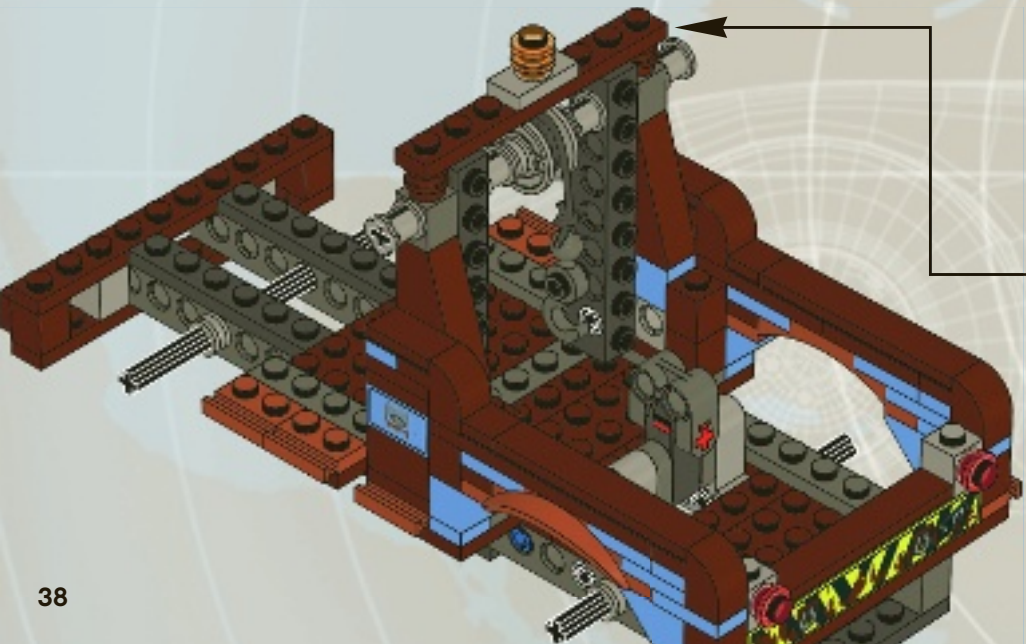

target  
acquired

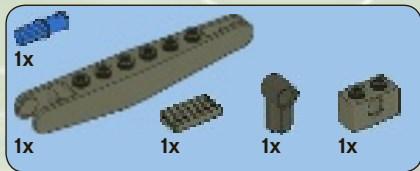

27

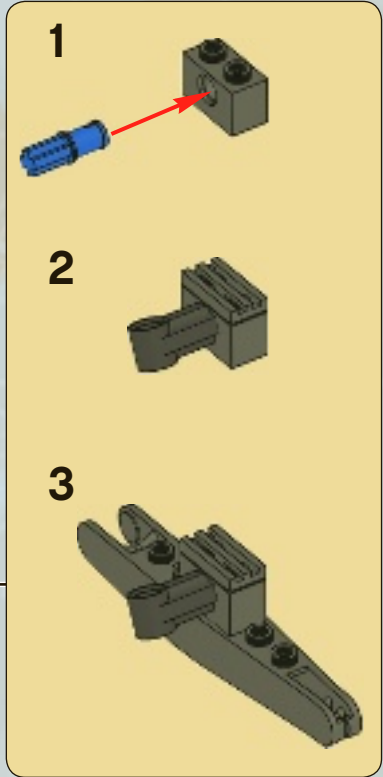
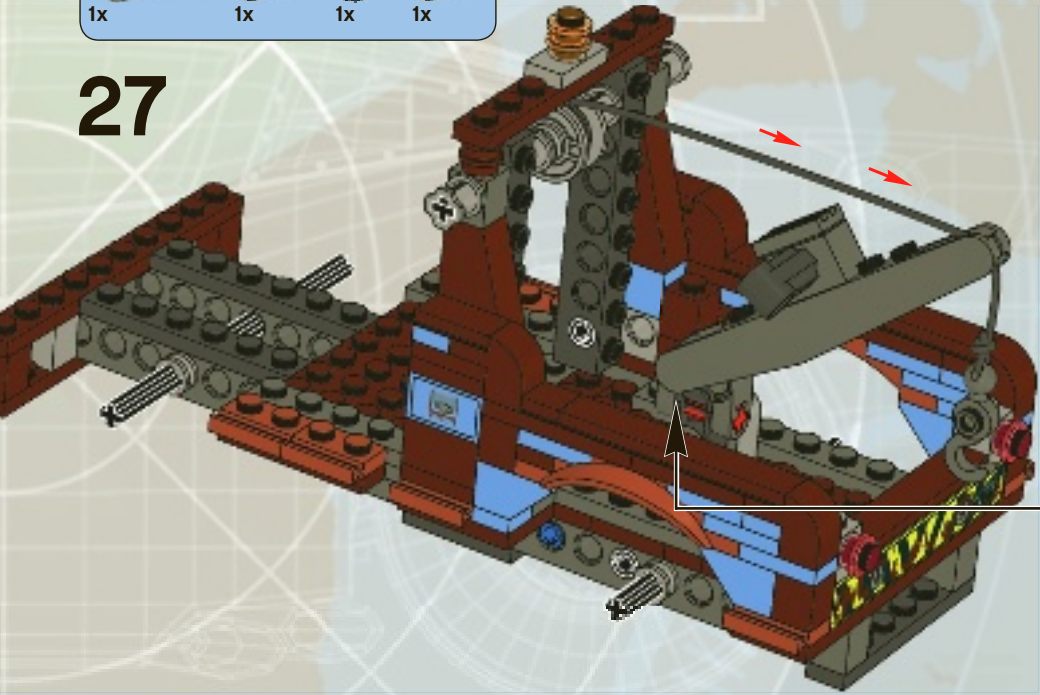

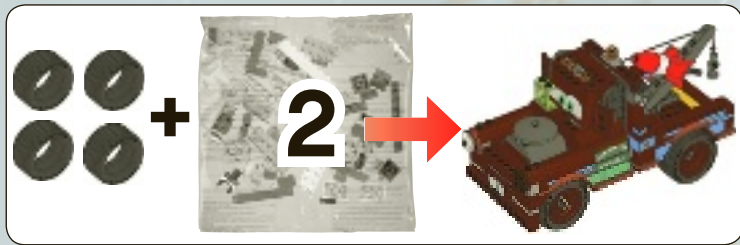

28

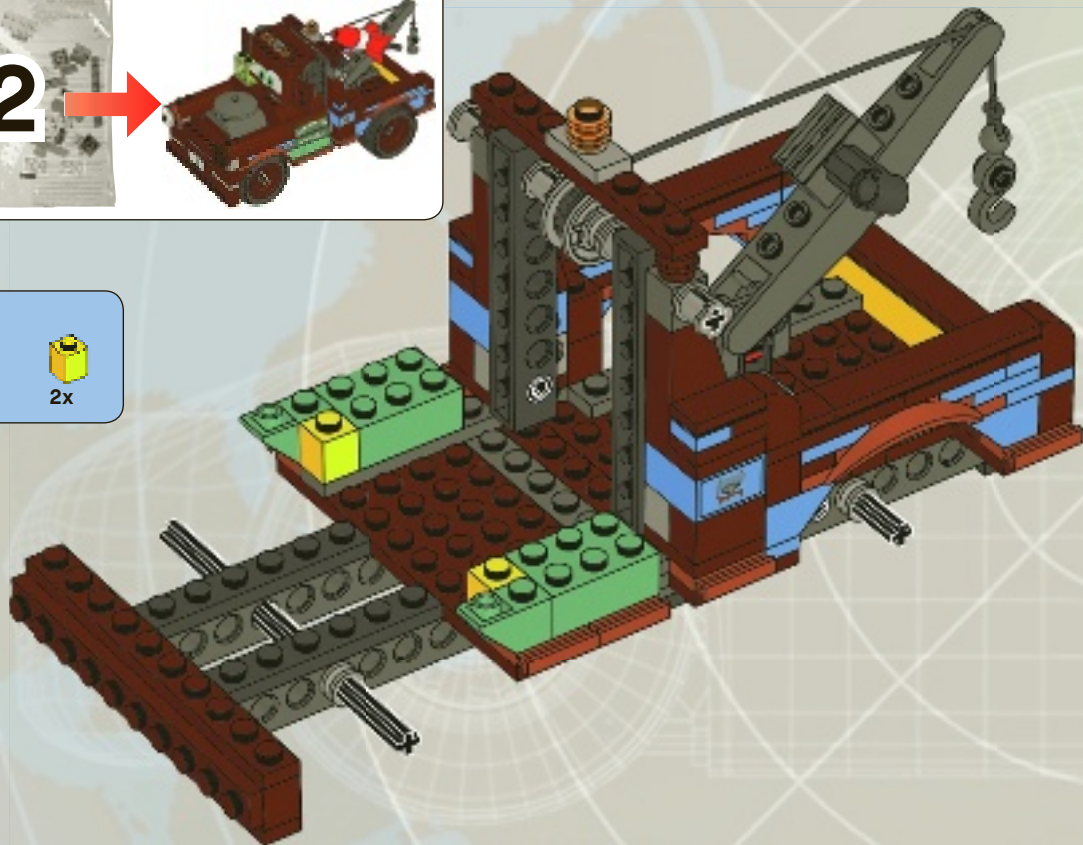



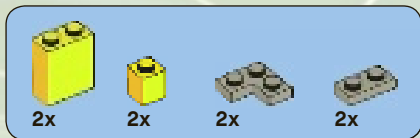

29

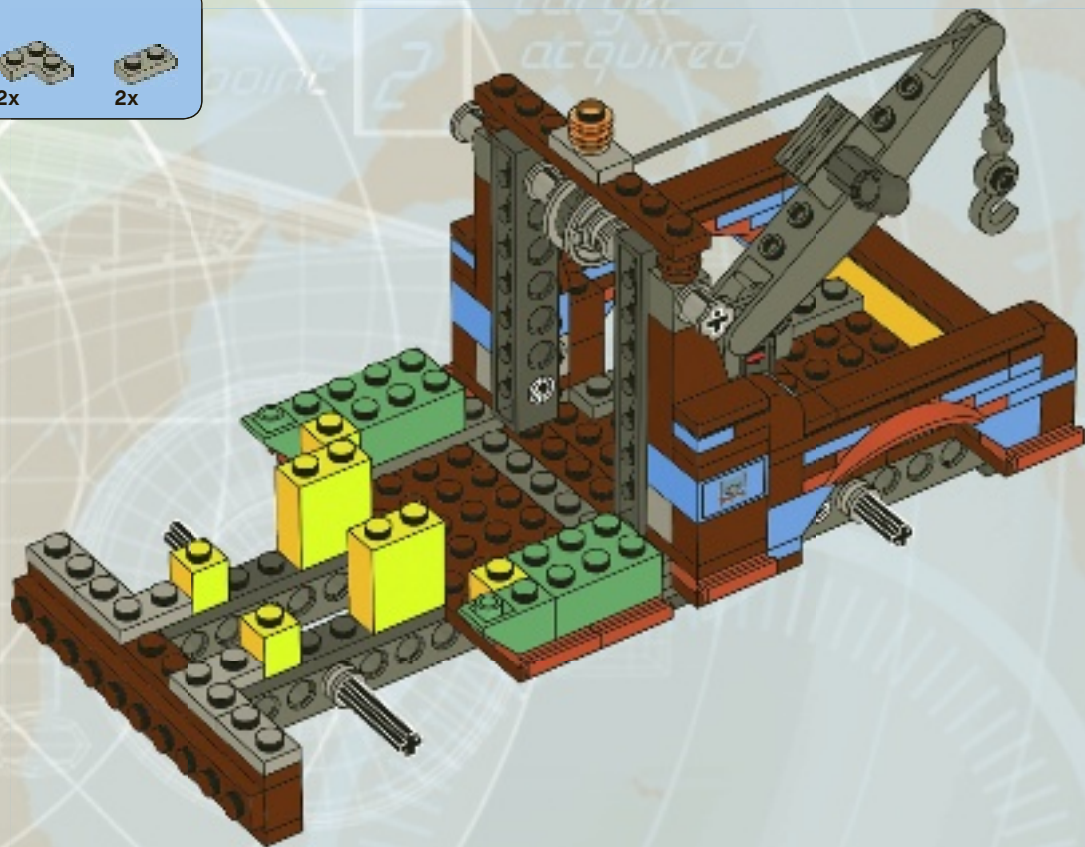



2x



4x

30

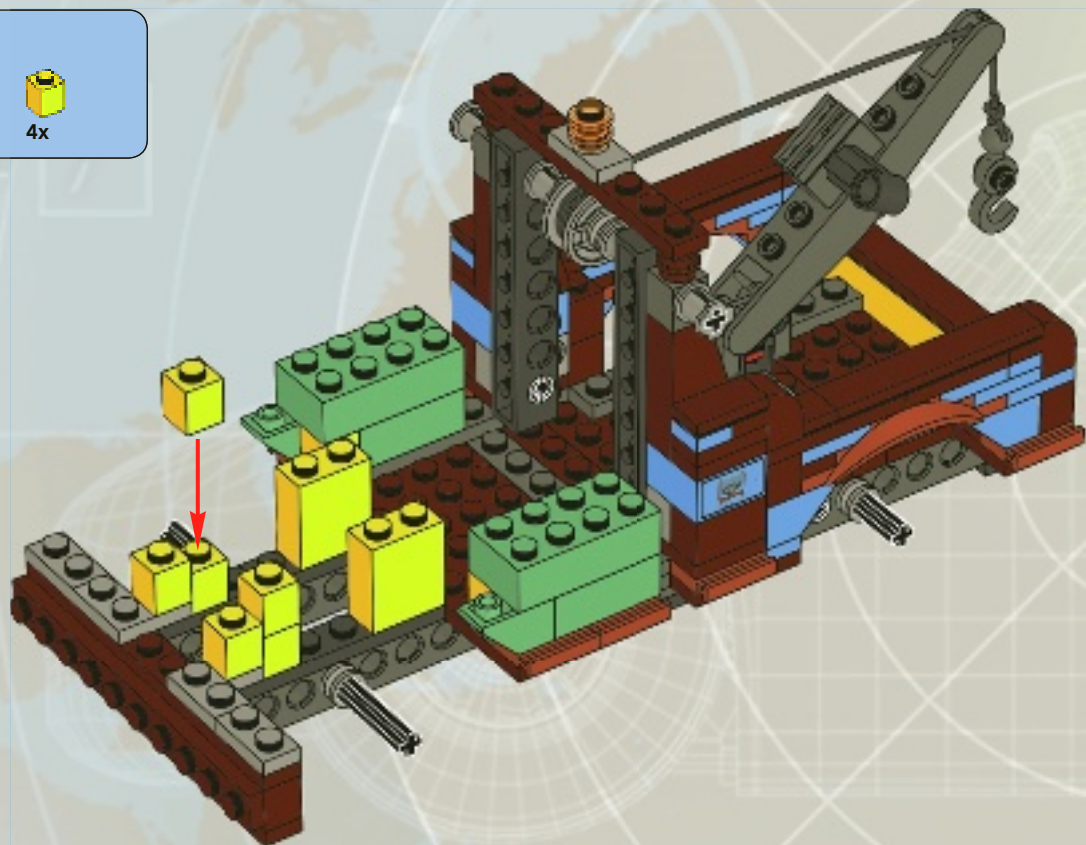



31

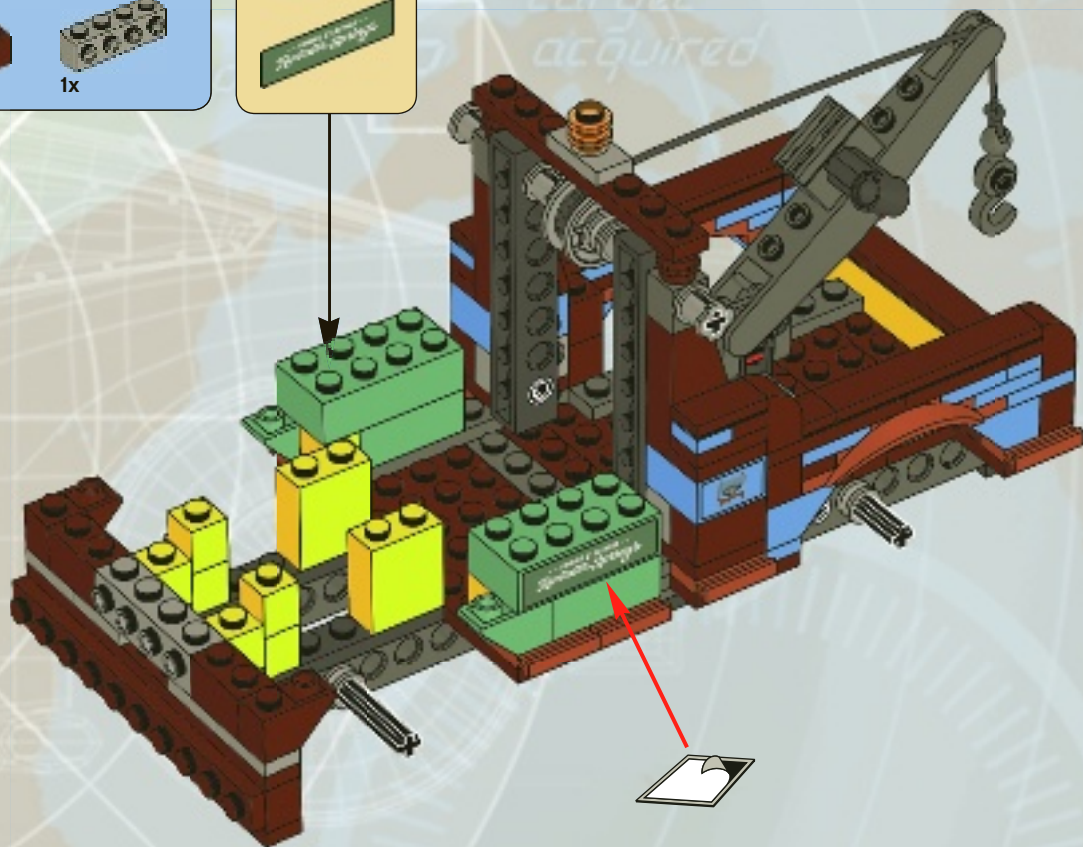

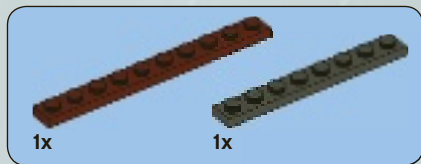

32

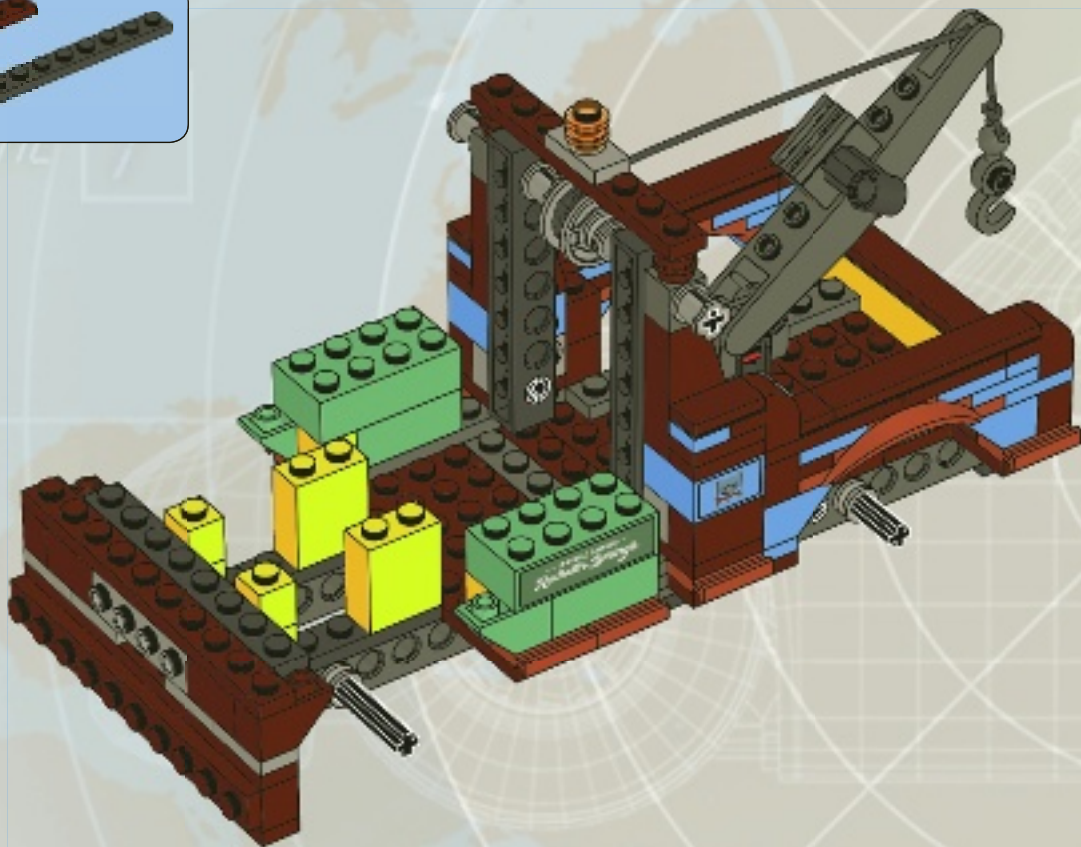

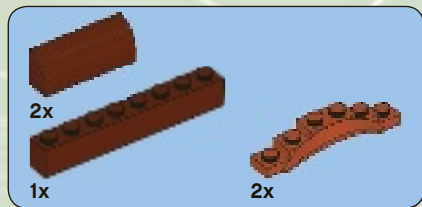

33

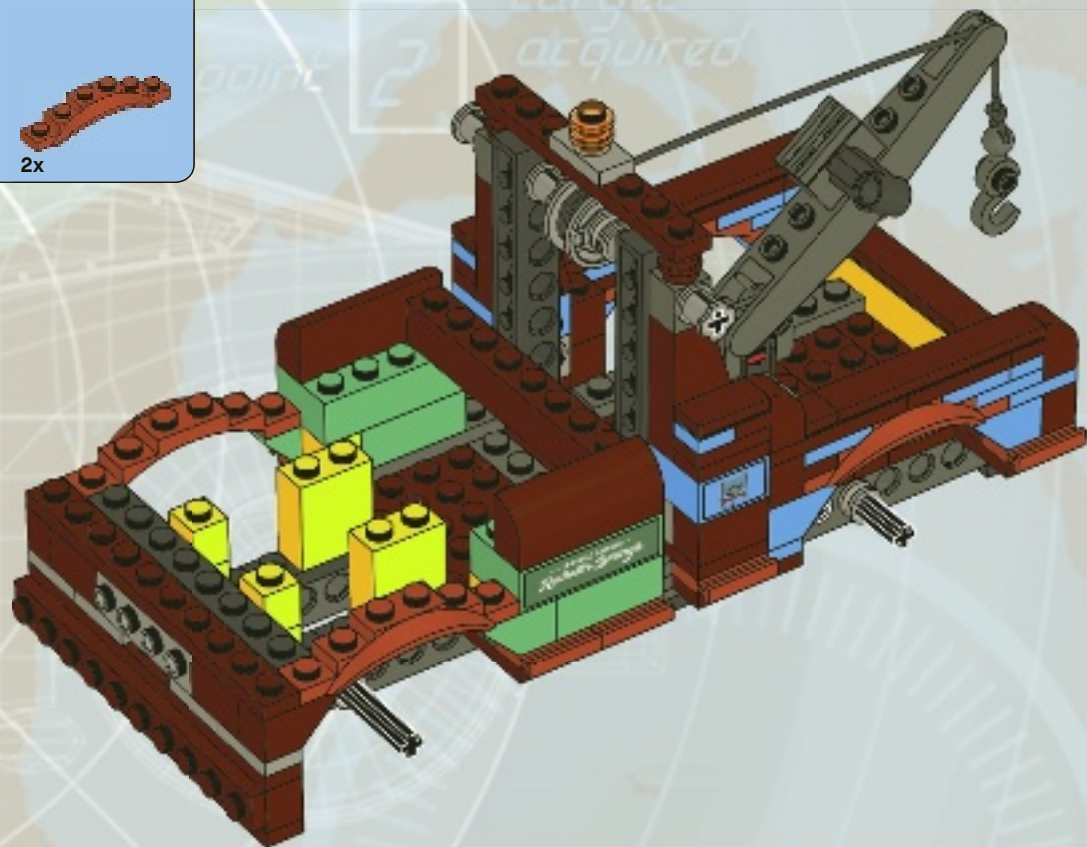



34

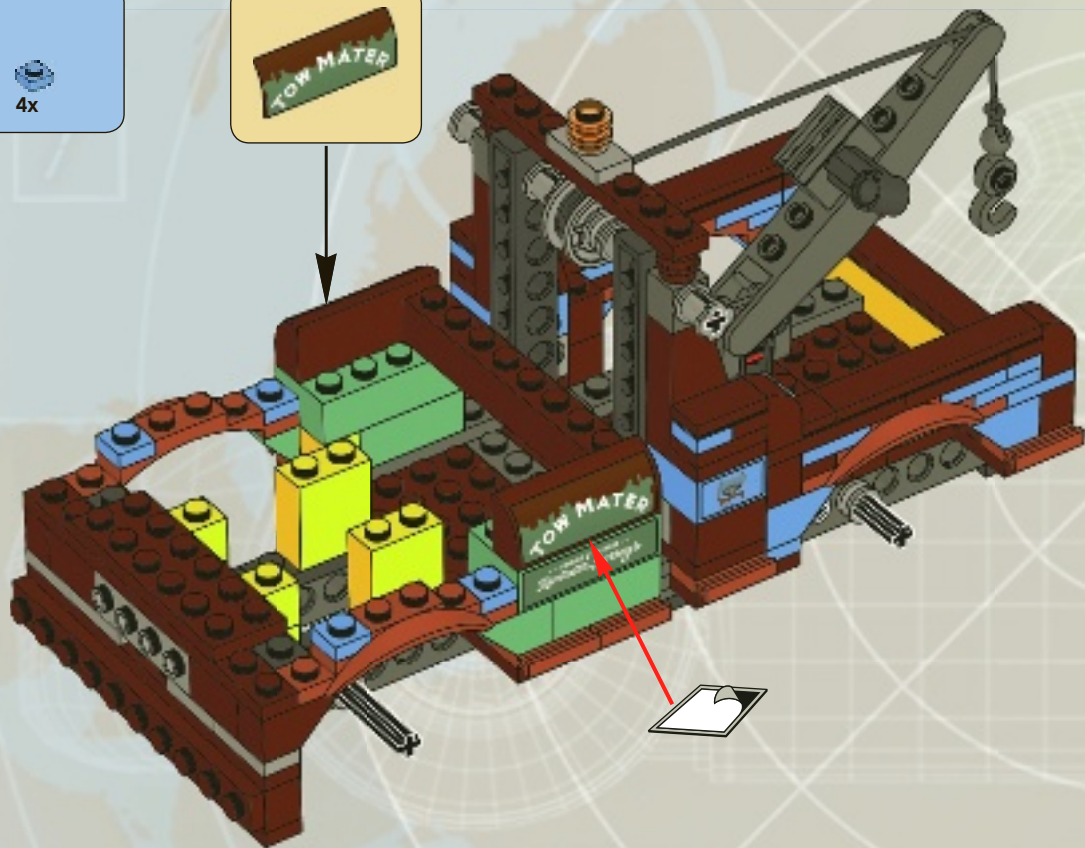

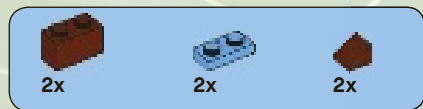

35



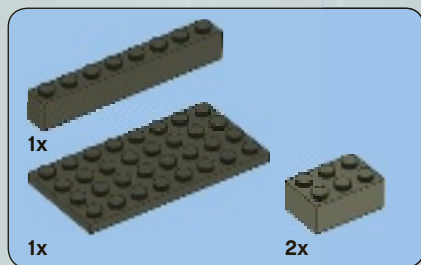

36

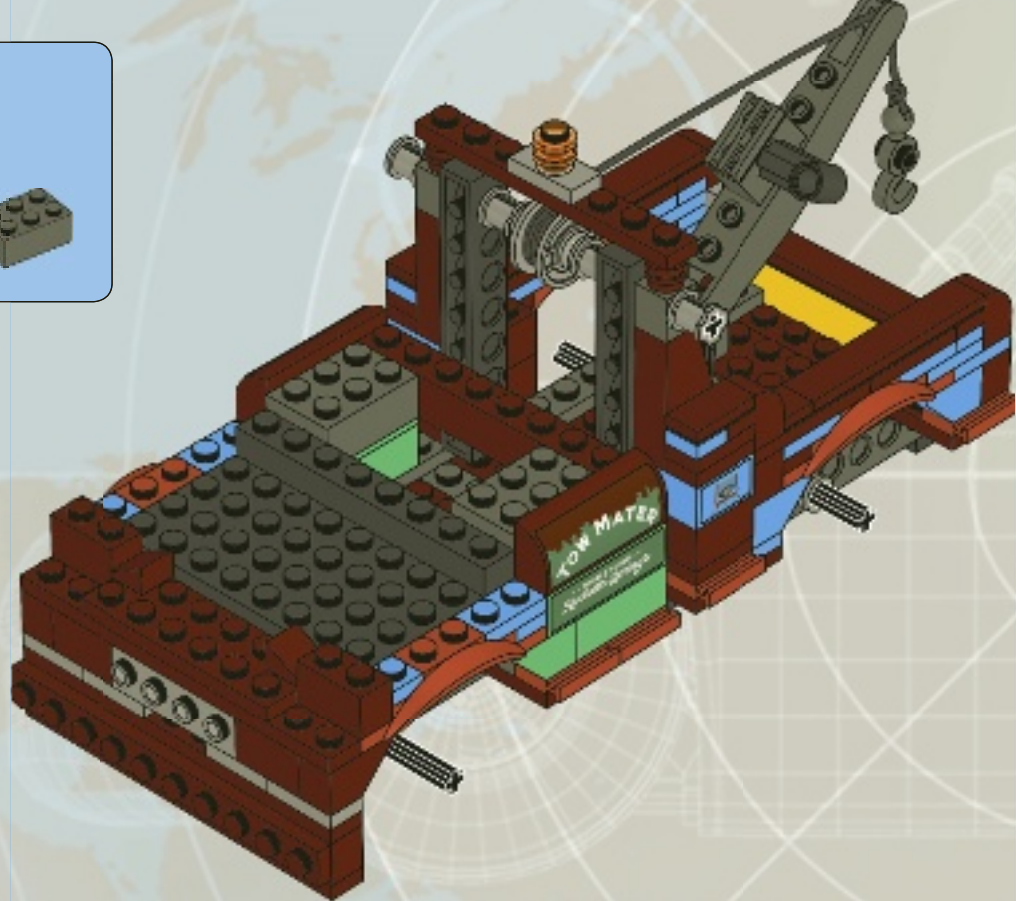





2x



4x

37

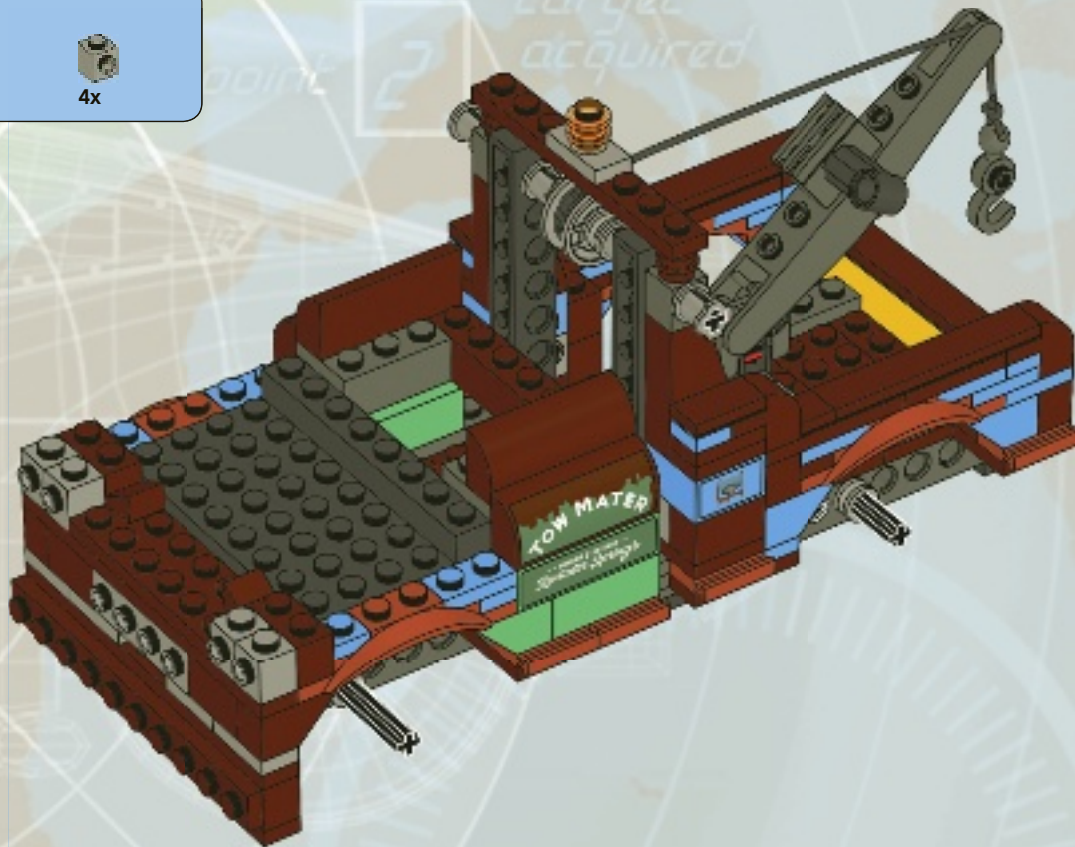

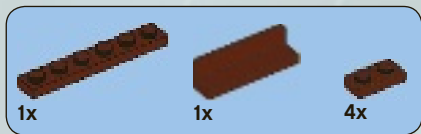

38

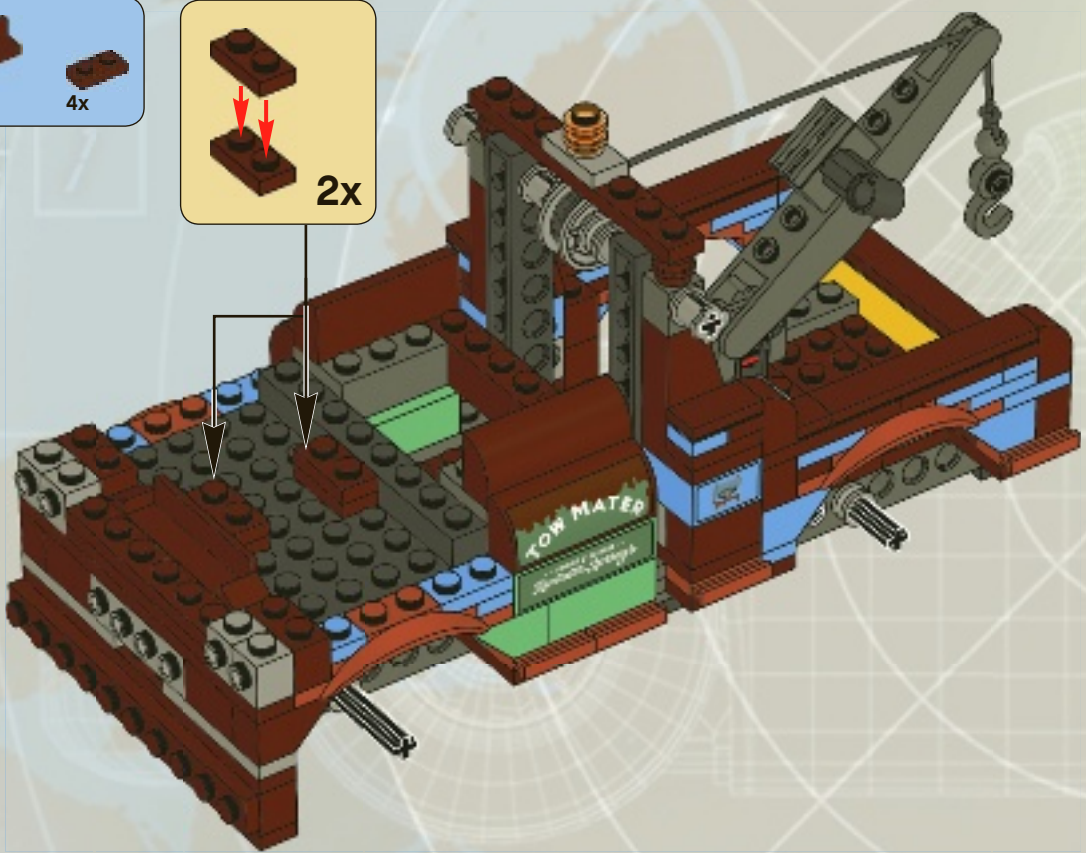
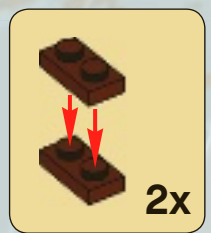

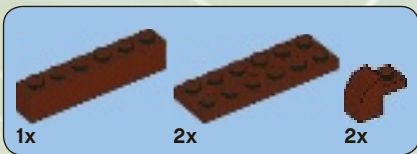

39

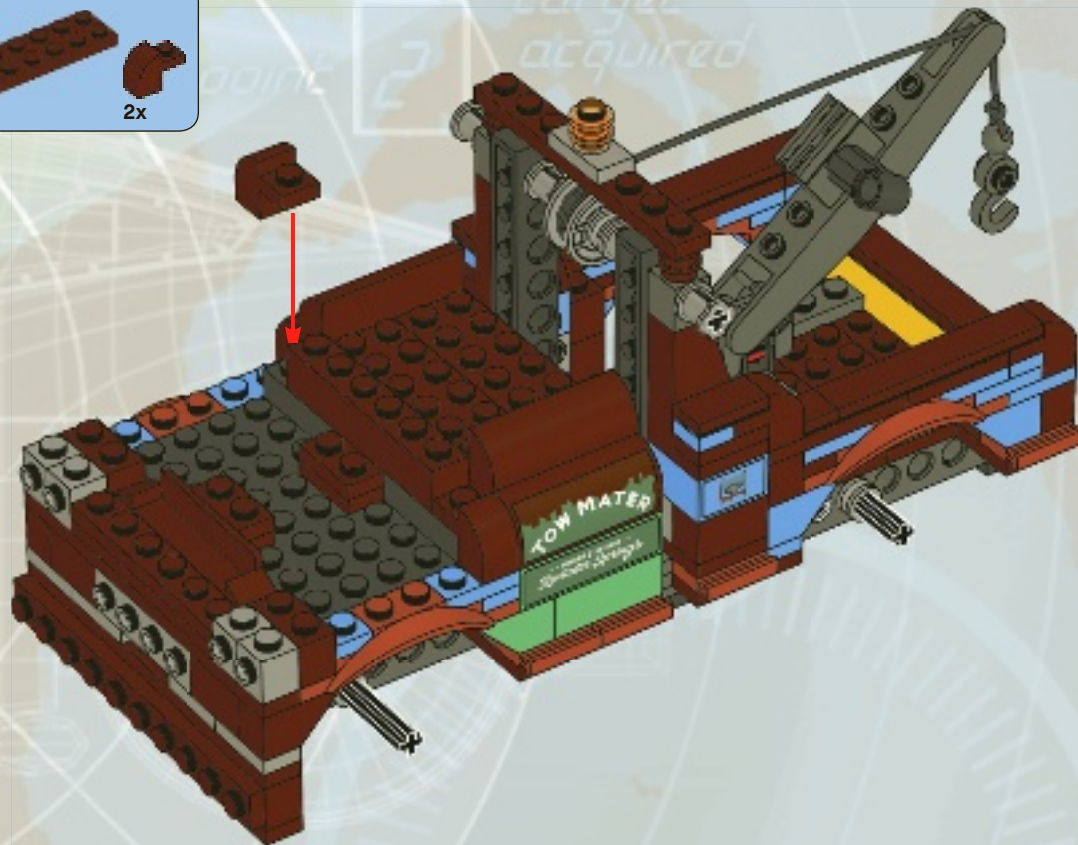



2x



2x

40

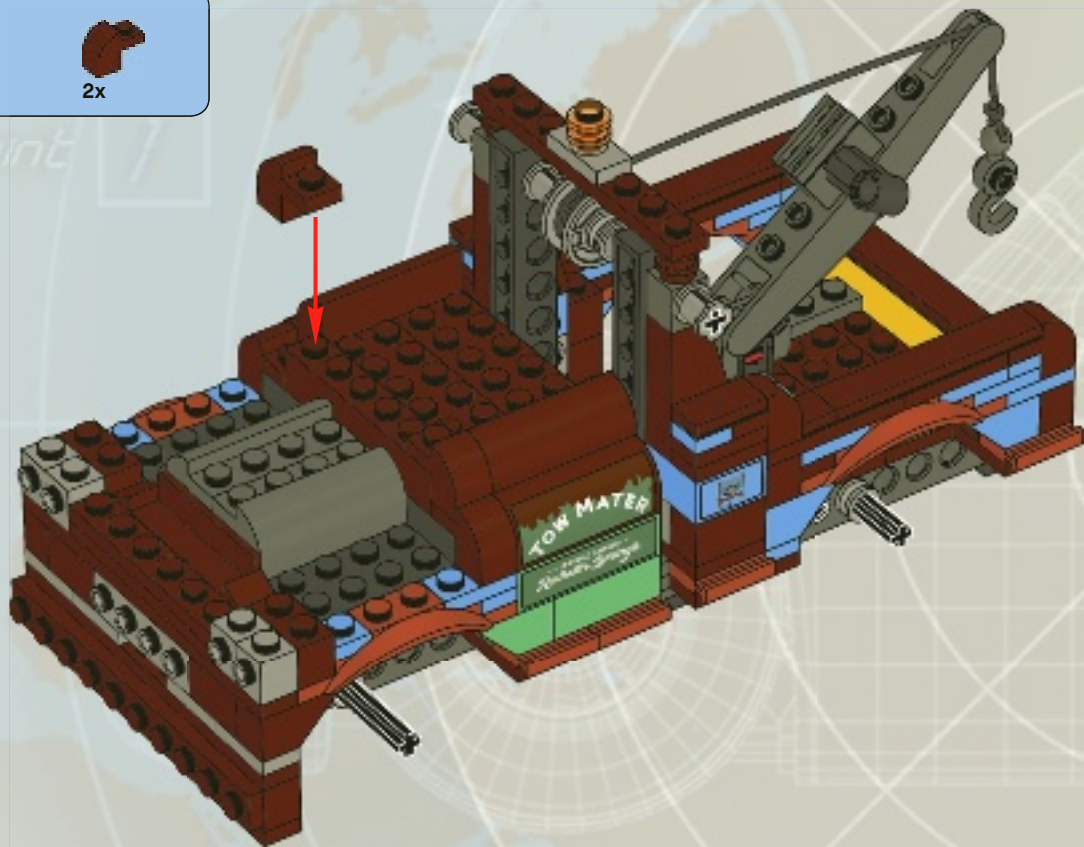



41

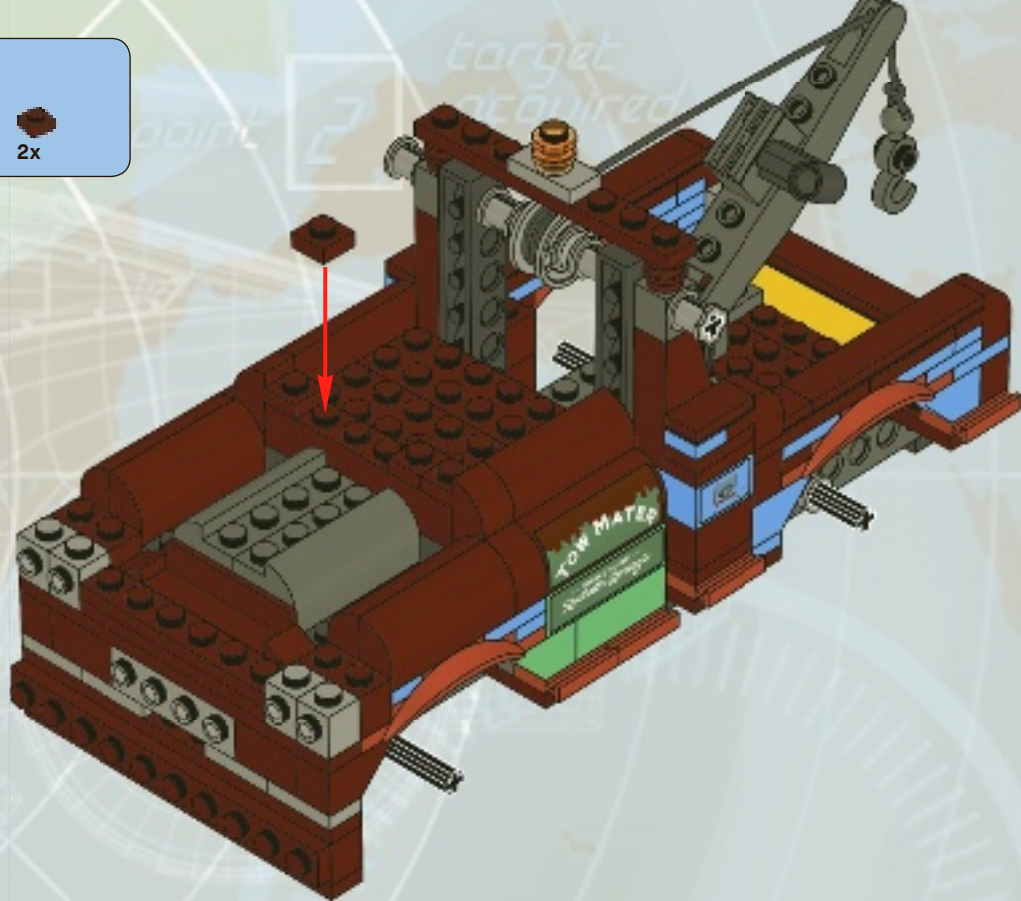

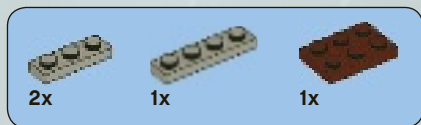

42

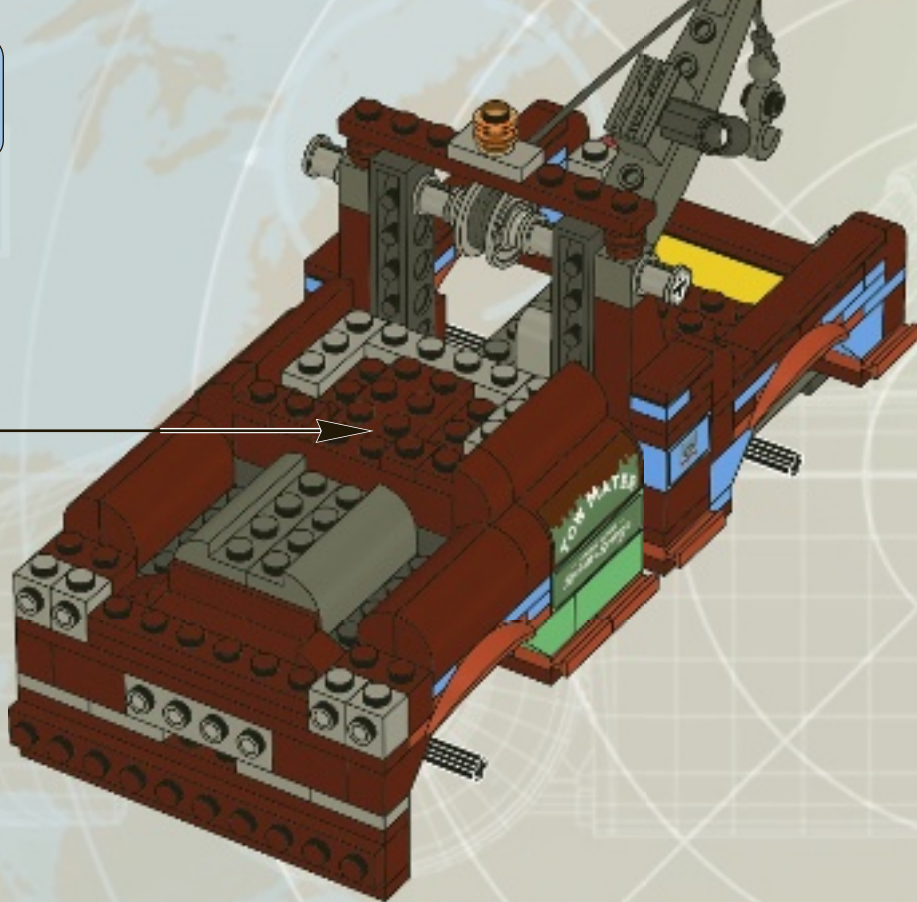



2x



2x

# 43

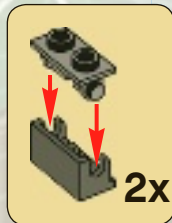

2x



target  
achieved

point 2

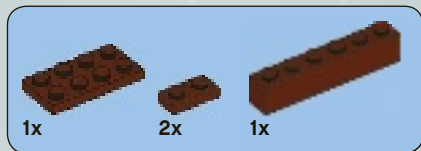

44







45

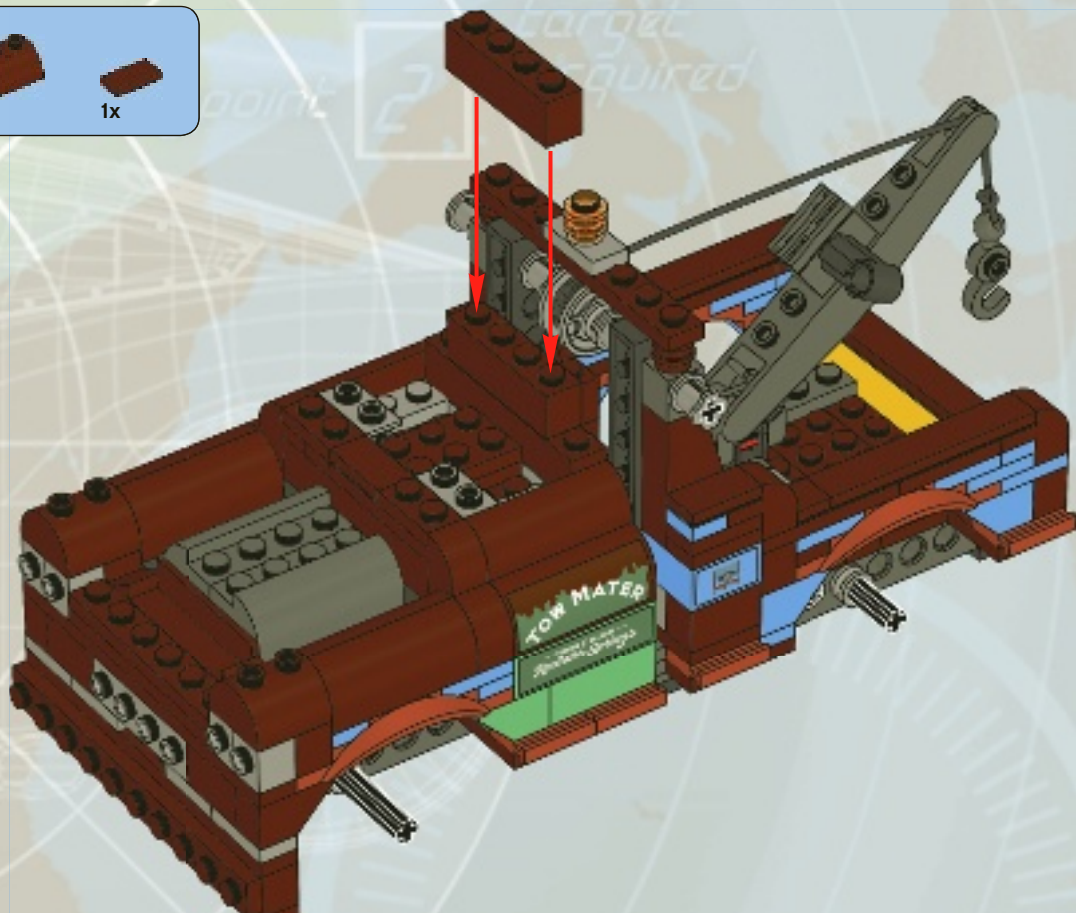



4x



1x



1x

# 46



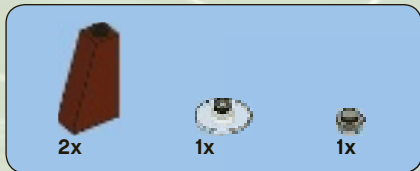

47

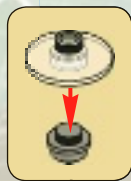



1x



1x

48





49





1x



1x

50



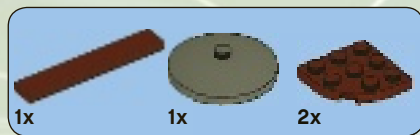

51





52





target  
acquired

point 2



# 53

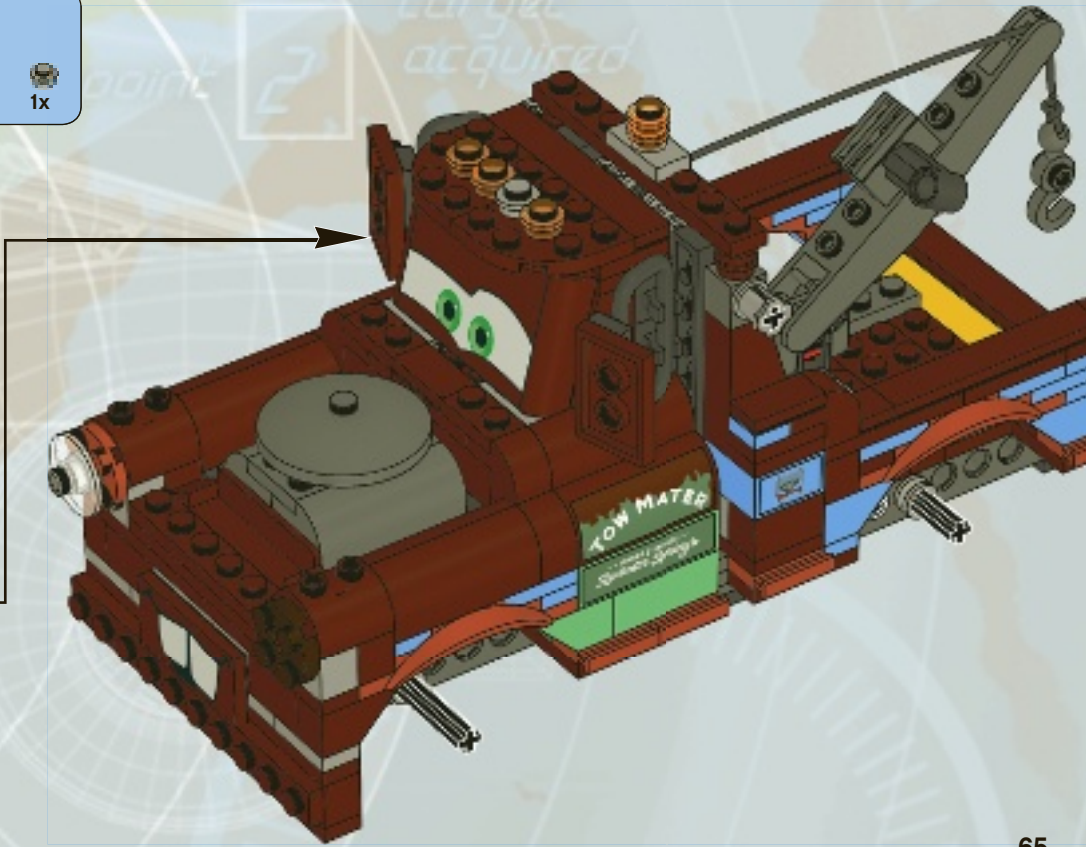

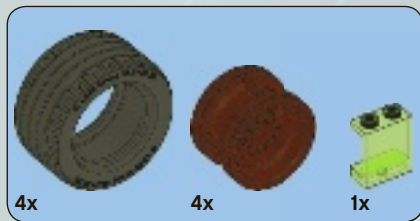

54



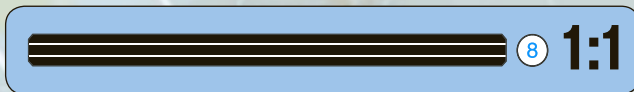
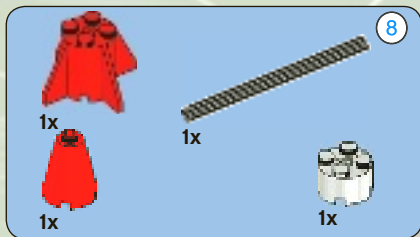

55

1



2



3

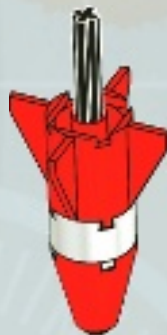

waypoint 7



1x  
614301

2x  
4528786

1x  
4528786

1x  
4570282

1x  
4142865

2x  
4143005

3x  
4206482

8x  
300524

2x  
4121625

1x  
300824

1x  
4187750

8x  
4121715

1x  
300826

4x  
4533771

4x  
4184286

2x  
370226

3x  
366626

1x  
346026

2x  
302126

1x  
4173970

1x  
4107085

2x  
4141349

1x  
370526

1x  
370726

3x  
373726

1x  
303526

8x  
4616022

2x  
4616027

4x  
4616054

2x  
3005741

2x  
4201235

4x  
4598015

10x  
4179826

10x  
4179825

2x  
4618537

2x  
4623295

2x  
4623297

5x  
4222960

1x  
4620598

8x  
4558953

2x  
4211470

1x  
4211636

2x  
4211541

2x  
4211398

2x  
4211353

2x  
4211429

1x  
4211445

1x  
4211451

2x  
4211525

1x  
4521532

2x  
4552348

6x  
4211573

4x  
4211622

4x  
4221744

2x  
4211288

13x  
4211150

3x  
4211150

6x  
4211242

8x  
4211149

2x  
4211225

2x  
4211193

1x  
4263776



4x  
4270470



2x  
4211190



1x  
4211186



1x  
4616052



4x  
4211204

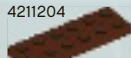

5x  
4211247



3x  
4221590

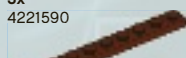

5x  
4223683

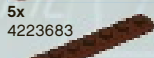

1x  
4216945



2x  
4283660



1x  
4565214



4x  
4618633



8x  
4505458



2x  
4618542



8x  
4618543



2x  
4216695



2x  
4211152



3x  
4211189



2x  
4504376



2x  
4211222

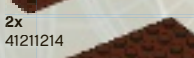

2x  
4121124

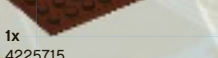

1x  
4225715



2x  
4211257

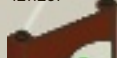

1x  
4616040



4x  
4216581



2x  
4210639



1x  
4211111



2x  
4211105



2x  
4210968



1x  
4212529



1x  
4210631



1x  
4223981



2x  
4211066



1x  
4234599



2x  
4210980



4x  
4211137

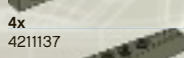

1x  
4620596

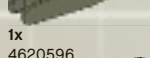

5x  
4210998



1x  
4211065



1x  
4623298

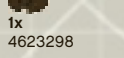

1x  
373726



Customer Service

Kundenservice

Service Consommateurs

Servicio Al Consumidor

[www.lego.com/service](http://www.lego.com/service) or dial



00800 5346 5555 :



1-800-422-5346 :



8484





# WIN!

Go to [www.LEGOsurvey.com/product](http://www.LEGOsurvey.com/product) to fill out a survey for a chance to win a cool LEGO® Product.

No purchase necessary.

Open to all residents where not prohibited.



## [www.LEGOsurvey.com/product](http://www.LEGOsurvey.com/product)

### GEWINNE!

Nimm an der Umfrage auf [www.LEGOsurvey.com/product](http://www.LEGOsurvey.com/product) teil und hab die Chance ein cooles LEGO® Produkt zu gewinnen!

Die Teilnahme am Gewinnspiel führt zu keinerlei Kaufverpflichtungen. Teilnahme in allen nicht ausgeschlossenen Ländern möglich.

### WIN!

Ga naar [www.LEGOsurvey.com/product](http://www.LEGOsurvey.com/product), vul een enquêteformulier in en maak kans op een cool LEGO® product.

Geen aankoopverplichting, iedereen mag deelnemen, uitgezonderd ingezetenden van landen waar een enquêteverbod geldt.

### GAGNE!

Visite [www.LEGOsurvey.com/product](http://www.LEGOsurvey.com/product) pour répondre à un questionnaire et avoir une chance de gagner un produit LEGO® très cool!

Aucune obligation d'achat. Ouvert à tous les résidents des pays autorisés.

### 当てよう!

[www.LEGOsurvey.com/product](http://www.LEGOsurvey.com/product) にアクセスして、アンケートにご記入ください。当選者にはレゴ®製品を差し上げます。

お買い上げの必要はありません。

禁止されていない限り、すべての皆様にご利用いただけます。

LEGO and the LEGO logo are trademarks of the/sonst des marques de commerce de/son marcas registradas de LEGO Group. ©2011 The LEGO Group.

© Disney/Pixar